

INSTALLATION INSTRUCTIONS AND OWNER'S MANUAL

INSTALLER:

Leave this manual with the appliance.

CONSUMER:

Retain this manual for future reference.

⚠ WARNING

FIRE OR EXPLOSION HAZARD

If the information in these instructions are not followed exactly, a fire or explosion may result causing property damage, personal injury or loss of life.

- Do not store or use gasoline or other flammable vapors and liquids in the vicinity of this or any other appliance.
- **WHAT TO DO IF YOU SMELL GAS**
 - Do not try to light any appliance.
 - Do not touch any electrical switch; do not use any phone in your building.
 - Leave the building immediately.
 - Immediately call your gas supplier from a neighbor's phone. Follow the gas supplier's instructions.
 - If you cannot reach your gas supplier, call the fire department.
- Installation and service must be performed by a qualified installer, service agency or the gas supplier.

⚠ WARNING

If not installed, operated and maintained in accordance with the manufacturer's instructions, this product could expose you to substances in fuel or from fuel combustion which can cause death or serious illness.

**LOG SET
MODELS:**
LS(18,24,30)CBS



SUPER BIRCH

LS24CBS
SHOWN

Log sets comply with ANSI Z21.11.2 Unvented Heaters and also comply with ANSI Z21.60 Decorative Vented Appliances for Solid Fuel Burning Fireplaces. State or local codes may only allow operation of log sets in a vented configuration. Check your state or local codes.

**NATIONAL
FIREPLACE
INSTITUTE**



CERTIFIED
www.nficertified.org

We suggest that our gas hearth products be installed and serviced by professionals who are certified in the U.S. by the National Fireplace Institute® (NFI) as NFI Gas Specialists.

Please See Our Website For Log Assembly Videos.

TABLE OF CONTENTS

| SECTION | PAGE |
|--|---------|
| Important Installation Guidelines..... | 3 |
| General Information | 3 |
| Requirements for Canada..... | 4 |
| LS(18,24,30)CBS - Log Sets..... | 5 |
| LS18CBS Log Identification | 6 |
| LS18CBS Log Placement | 7 - 15 |
| LS18CBS Ember Placement..... | 16 |
| LS24CBS Log Identification | 17 |
| LS24CBS Log Placement | 18 - 26 |
| LS24CBS Ember Placement..... | 27 |
| LS30CBS Log Identification | 28 |
| LS30CBS Log Placement | 29 - 37 |
| LS30CBS Ember Placement..... | 38 |
| Master Parts Distributor List..... | 39 |
| How To Order Repair Parts | 39 |

IMPORTANT INSTALLATION GUIDELINES

Proper Log Placement

Log placement is critical to proper burner performance. Logs must be correctly positioned onto the burner. The photos in this manual show the proper pinned position for logs on this set. Owners need to be shown proper log placement and instructed not to move the logs.

Logs must fit firmly onto the burner when positioned as shown in the photos. Malformed logs or logs with sloppy pin holes must be replaced.

Proper Placement of Rock Wool and Decorative Lava Rock

Rock wool can be added to burners for a glowing ember effect. Place on the front portion of the burner only. The photos in this manual show the proper placement of rock wool.

Never place decorative lava rock or small wood pieces on the burner. Place them on the floor of the fireplace or firebox only.

Proper Primary Airflow into Burner

For proper burner operation and flame appearance, the flow of primary air into the venturi tube, located on the rear of the burner, must not be reduced. Air flow may be reduced if dirt, lint or other obstructions build-up around or inside the venturi. Any obstruction must be removed. Air flow into the venturi is also reduced if the gas orifice isn't centered in the venturi inlet or is not aligned with the venturi. Correct any misalignment of the burner orifice by bending the shutter cap holding the orifice to the inlet of the venturi tube.

Ceiling Fans, Portable Fans or Logs Installed Near Cold Air Returns

Ceiling fans or oscillating fans need to be monitored during the operation of this vent-free burner. If air blows directly into the flame causing it to impinge on the log set, or firebox, turn off or redirect the fan. Ceiling fans may be reversed to eliminate flame impingement. Upon installation, be aware of any cold-air returns or vents in the proximity of the burner. Any draft created around a vent-free burner can cause flame impingement and create soot.

WARNING

Do not allow fans to blow directly into the fireplace. Avoid any drafts that alter burner flame patterns.

WARNING

Do not use a blower insert, heat exchanger insert or other accessory not approved for use with this heater.

Candles

Avoid the use of scented or decorative candles while the log set is in operation. Candles produce a residue in the air that creates a soot-like substance. Burning candles while the burner is operating magnifies the problem. Candles in general produce soot. The amount of time burned and the quantity of candles will determine the amount of soot produced.

Make Owners Aware of Proper Log Set Operation

Properly installed and properly maintained log sets do not deposit soot on the logs. If users see soot on a log, they should call for service. Do not continue to operate the log set.

Sunken Fireplace

If installing this unit into a sunken fireplace, raise the floor to ensure adequate airflow and guard against sooting. Raise fireplace floor using a non-combustible material, which is secure.

Glass Doors

Keep glass doors open during all operations of the logset. The opening of the glass door frame should be the dimension used for the minimum front opening of the firebox.

Wood-Burning Fireplaces

The interior of the firebox and the chimney must be cleaned and free of all creosote before installing a gas log set. Creosote will soften when heated and can drop onto the logset causing odors and soot.

WARNING

Before installing in a solid-fuel burning fireplace, the chimney flue and firebox must be cleaned of soot, creosote, ashes and loose paint by a qualified chimney cleaner.

Initial Operation

Once the installation is complete and the logs and embers are in place, light the burner and operate it on high for a minimum of three continuous hours. This will burn off any foreign materials, such as dust or paint overspray, that might cause odors during normal operation. Open windows or doors as needed to allow odors and excess heat to escape.

GENERAL INFORMATION

Qualified Installing Agency

Installation and replacement of gas piping, gas utilization equipment or accessories and repair and servicing of equipment shall be performed only by a qualified agency. The term "qualified agency" means any individual, firm, corporation, or company that either in person or through a representative is engaged in and is responsible for (a) the installation, testing, or replacement of gas piping or (b) the connection, installation, testing, repair, or servicing of equipment; that is experienced in such work; that is familiar with all precautions required, and that has complied with all the requirements of the authority having jurisdiction.

The installation must conform with local codes or, in the absence of local codes, with the *National Fuel Gas Code, ANSI Z223.1/NFPA54*. *
*Available from the American National Standards Institute, Inc. 11 West 42nd St., New York, N.Y. 10018.

Commonwealth of Massachusetts: The installation must be made by a licensed plumber or gas fitter in the Commonwealth of Massachusetts. Sellers of unvented propane or natural gas-fired supplemental room heaters shall provide to each purchaser a copy of 527 CMR 30 upon sale of the unit. In the Commonwealth of Massachusetts, unvented propane and natural gas-fired space heaters shall be prohibited in bedrooms and bathrooms.

REQUIREMENTS FOR CANADA

This unit **cannot** be installed in a UNVENTED application, this unit **can only** be installed as a VENTED application with these requirements.

IMPORTANT SAFETY INFORMATION

This unit complies with ANSI Z21.60 and CGA 2.26 Decorative Gas Appliances For Installation In Solid Fuel Burning Fireplaces. Do not burn wood or solid fuels in a fireplace where a decorative gas log set is installed. This appliance is for installation only in a solid fuel burning fireplace, masonry fireplace or manufactured fireplace.

WARNING

Any modification to this gas log set can be dangerous. Improper installation or use of the gas log set can cause serious injury or death from fire, burns, explosion or carbon monoxide poisoning.

1. Please follow all local codes regarding installation, combustion and ventilation air or in the absence of local codes follow the National Fuel Gas Code ANSI Z223.1 (U.S. installation), or CAN/CGA-B149, Installation Code (Canada installation).
2. Proper installation, burner location and log placement is important to achieve optimum look and performance of your gas log set. The logs have been designed for easy location and placement on the grate and must be followed for proper operation.
3. Do not operate the burner with glass doors in the closed position. A fireplace screen must be in place when the burner is burning. Adequate combustion air must be provided for proper venting. All flames should go up and out the top of the firebox into the flue vent. If any flames float or curl forward into the room do not operate appliance. Check for an open flue and adequate combustion air into the room. A damper clamp must be installed on the firebox damper to maintain an open flue vent condition. Refer to fireplace owners manual INSTALLING DAMPER CLAMP section.
4. Young children must be carefully supervised when they are in the same room as an operating vent-free burner. Do not place stockings, clothing or any flammable material above or near the fireplace.
5. Do not substitute or use materials other than those supplied for use with the log set.
6. Also refer to IMPORTANT SAFETY INFORMATION in the fireplace Owner's Manual.

WARNING

DO NOT OPERATE THIS GAS LOG SET WITH GLASS DOORS CLOSED

- Clothing or other flammable material should not be placed on or near the appliance.
- Do not place trash or other articles on the log set during operation.
- During manufacturing, fabricating and shipping, various components of this appliance are treated with certain oils, films or bonding agents. These bonding agents are not harmful but may produce annoying smoke and smells as they are burned off during initial operation of the appliance. This is a normal temporary occurrence. A window should be opened during the initial bake out period.
- Keep burner and control compartment clean.
- **WARNING:** Before installing in a solid fuel burning fireplace, the chimney flue and firebox must be cleaned of soot, creosote, ashes and loose paint by a qualified chimney cleaner.
- Installation and repair should be done by a qualified service person. The appliance should be inspected before use and at least annually by a qualified service person. More frequent cleaning may be required due to excessive lint from carpeting, bedding materials, etc. It is imperative that control compartments, burners and circulating air passageways of the appliance be kept clean.
- Do not put anything around the fireplace that will obstruct the flow of ventilation air.
- Do keep the appliance area clear and free from combustible material, gasoline and other flammable vapors and liquids.
- A yearly examination and cleaning of the venting system of the solid-fuel burning fireplace must be performed by a qualified agency.
- Do make a periodic visual check of pilot and burners. Clean and replace damaged parts.
- Do not use this appliance if any part has been under water. Immediately call a qualified service technician to inspect the appliance and to replace any part of the control system and any gas control which has been under water.
- Never burn solid fuels in fireplace where a gas log set is installed.
- This unit complies with ANSI Z21.60 Decorative Vented Appliances for Solid Fuel Burning Fireplaces. State or local codes may only allow operation of this appliance in a vented configuration. Check your state or local codes.

LS(18,24,30)CBS - LOG SETS



LS18CBS - LOG SET

















LS24CBS - LOG SET



LS30CBS - LOG SET

LOG IDENTIFICATION - LS18CBS

| PART NUMBER & DESCRIPTION | TOP VIEW | FRONT VIEW |
|----------------------------------|---|---|
| R13496 Rear Left Log (A) |  |  |
| R13497 Rear Right Log (B) |  |  |
| R13498 Front Left Log (C) |  |  |
| R13499 Front Right Log (D) |  |  |
| R13500 Side Left Log (E) |  |  |
| R13501 Center Log (F) |  |  |
| R13502 Side Right Log (G) |  |  |

LOG PLACEMENT LS18CBS

Before you begin: Do not, handle these logs with your bare hands! Always wear gloves to prevent skin irritation. After handling logs, wash your hands gently with soap and water.

All Logs

The positioning of the logs is critical to the safe and clean operation of this heater. Sooting and other problems may result if the logs are not properly and firmly positioned in the appliance.

Refer to Figure 1 for the following warning.

⚠ WARNING

Failure to position the parts in accordance with this diagram or failure to use only parts specifically approved with this appliance may result in property damage or personal injury.

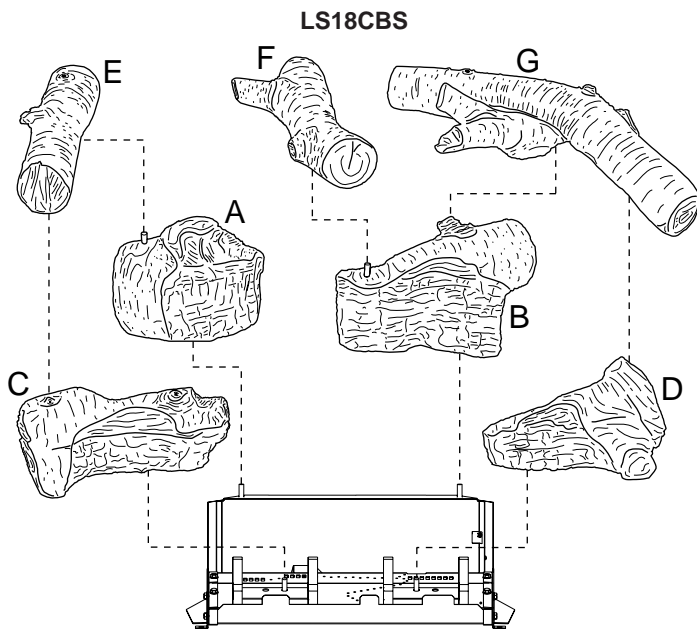

Figure 1

ATTENTION: Do not use Figure 1 to order replacement logs. Refer to Log Identification LS18CBS on Page 6 log to order logs for your appropriate model number.

The following **WARNING** applies when log set is installed onto an unvented gas burner assembly.

⚠ WARNING

This appliance is equipped for natural or propane gas. Field conversion is not permitted.

Apply glowing embers per the ember placement section of this manual on page 16. Replace glowing embers with appropriate part number from the table below from Empire Comfort Systems, Inc. Application of excess glowing embers may adversely affect performance of the heater.

⚠ WARNING

All previously applied loose material must be removed prior to reapplication.

LOG PLACEMENT LS18CBS (CONT'D)

1. Place **Log (A)** onto left rear pin on rear log support.

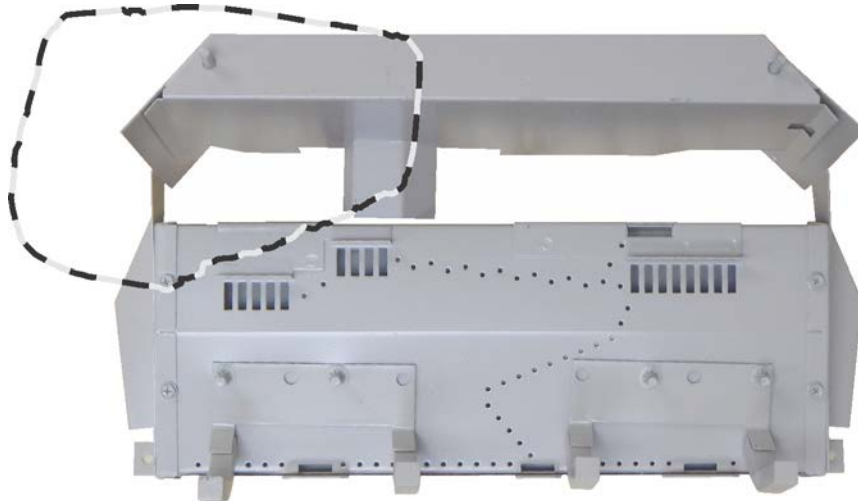

TOP VIEW



A

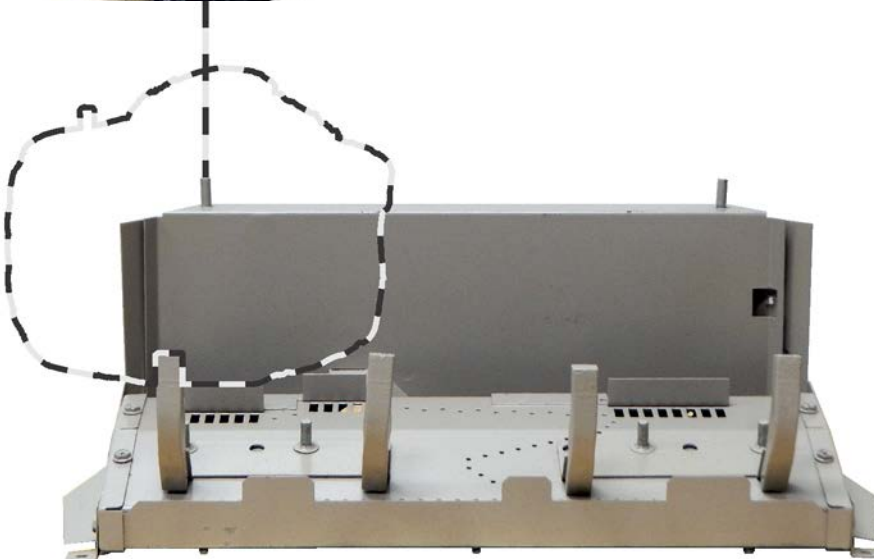

FRONT VIEW

LOG PLACEMENT LS18CBS (CONT'D)

- Place **Log (B)** onto right rear pin on rear log support.

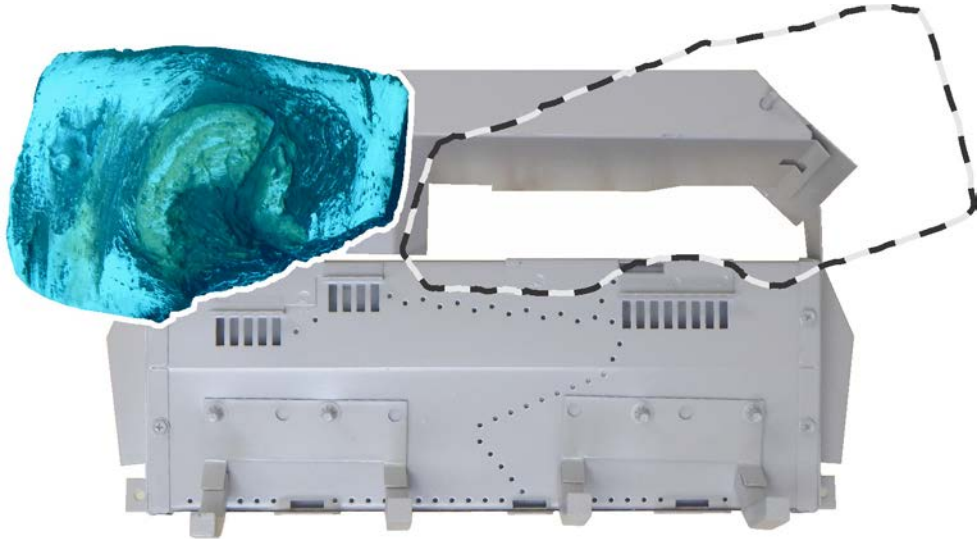

TOP VIEW

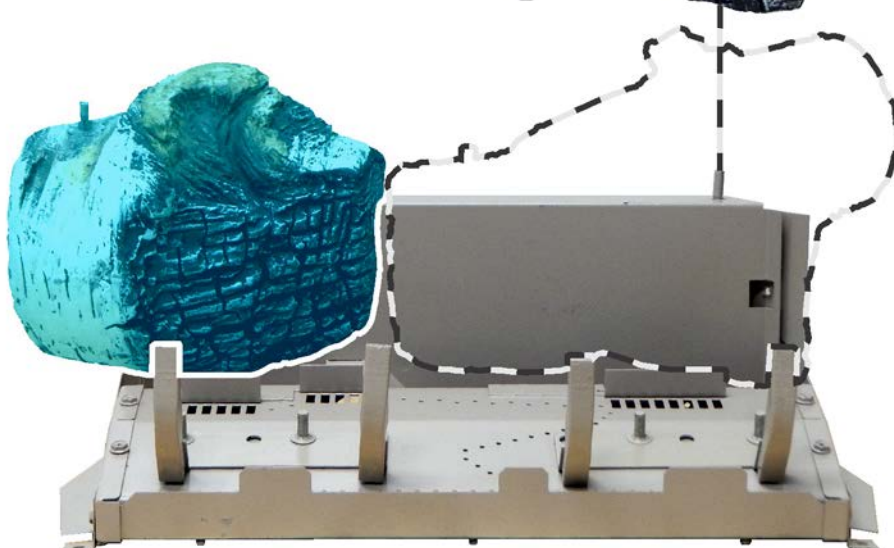

FRONT VIEW

LOG PLACEMENT LS18CBS (CONT'D)

3. Place **Log (C)** onto left front pin on burner pan.

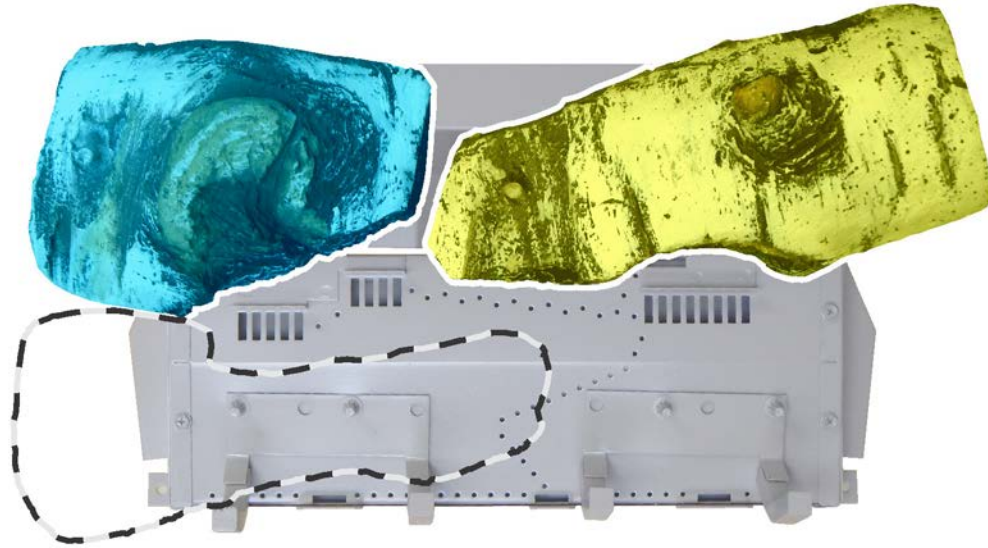

TOP VIEW

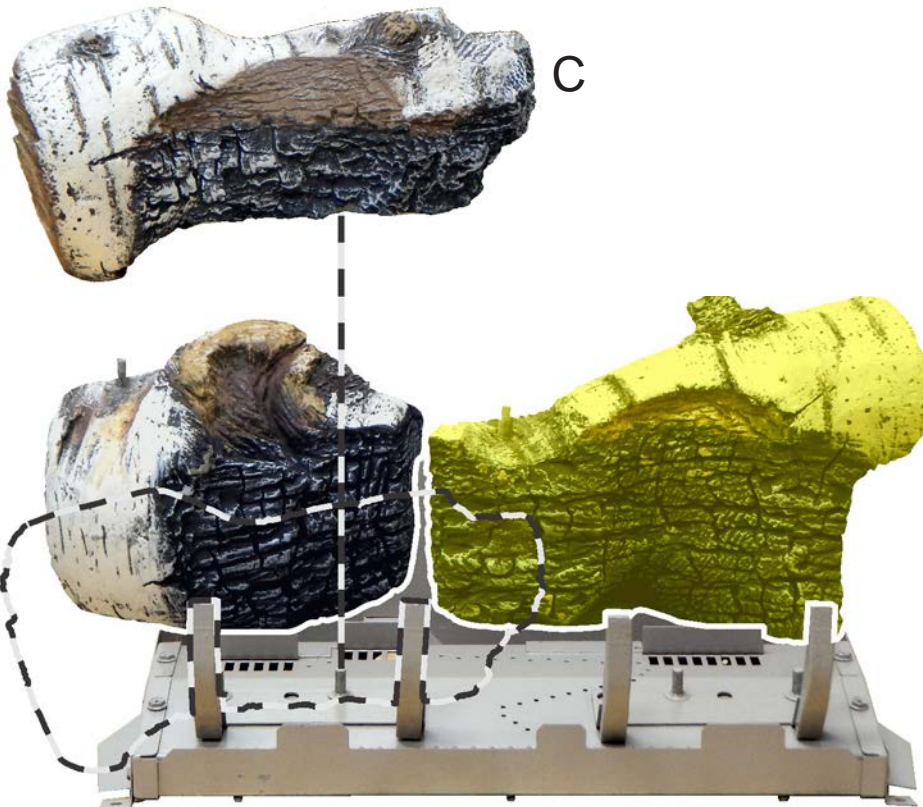

FRONT VIEW

LOG PLACEMENT LS18CBS (CONT'D)

- Place **Log (D)** onto right front pin on burner pan.

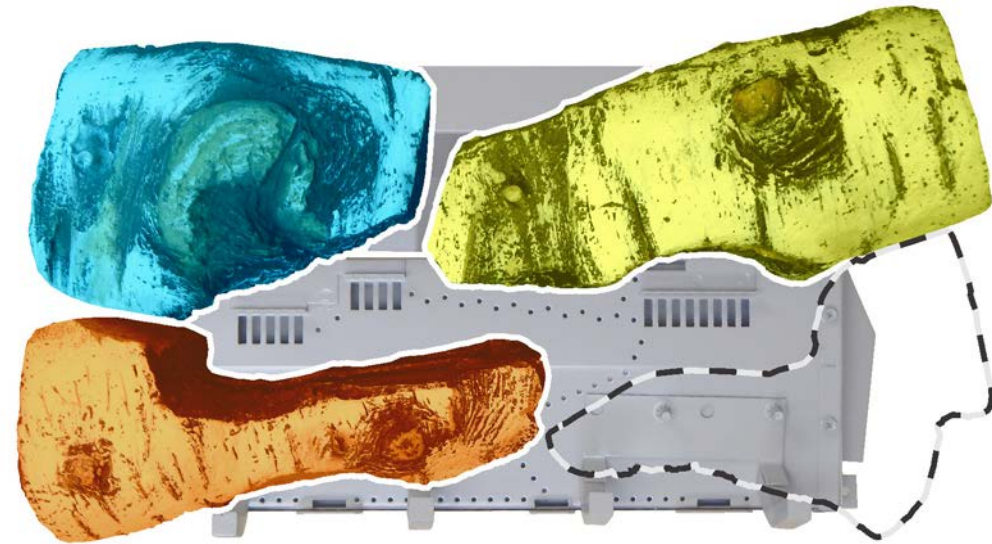

TOP VIEW

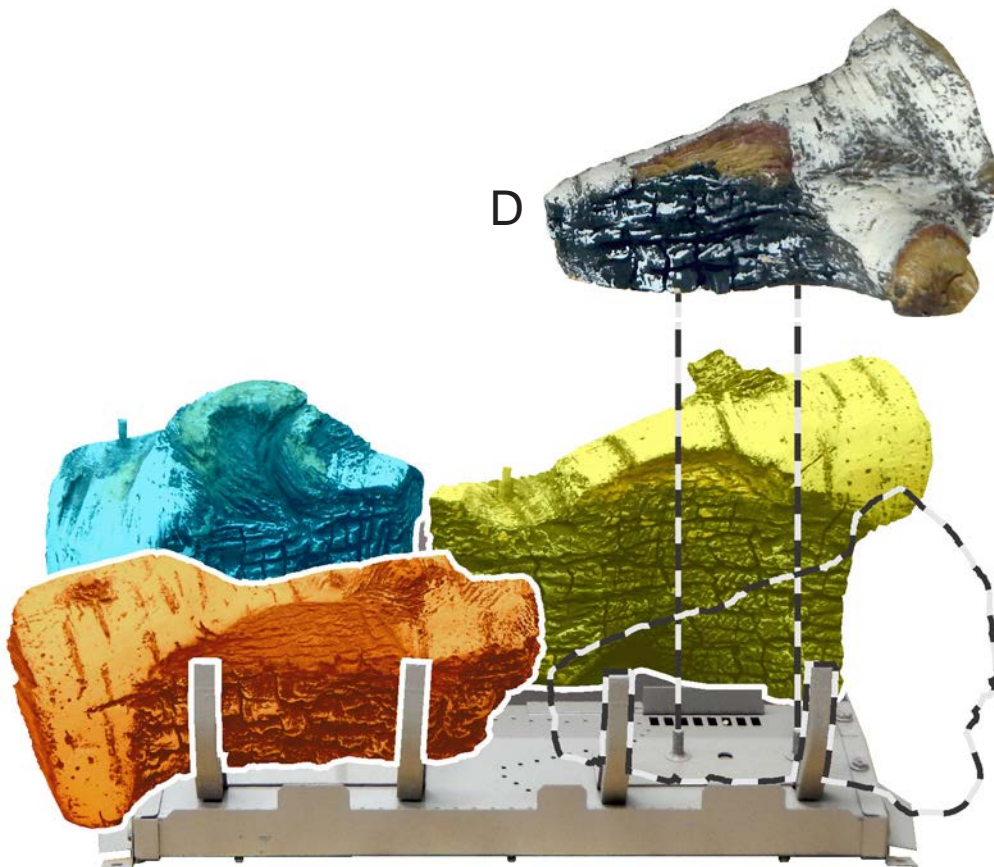

FRONT VIEW

LOG PLACEMENT LS18CBS (CONT'D)

5. Place **Log (E)** onto left side pins of **Log (A)** and **Log (C)**.

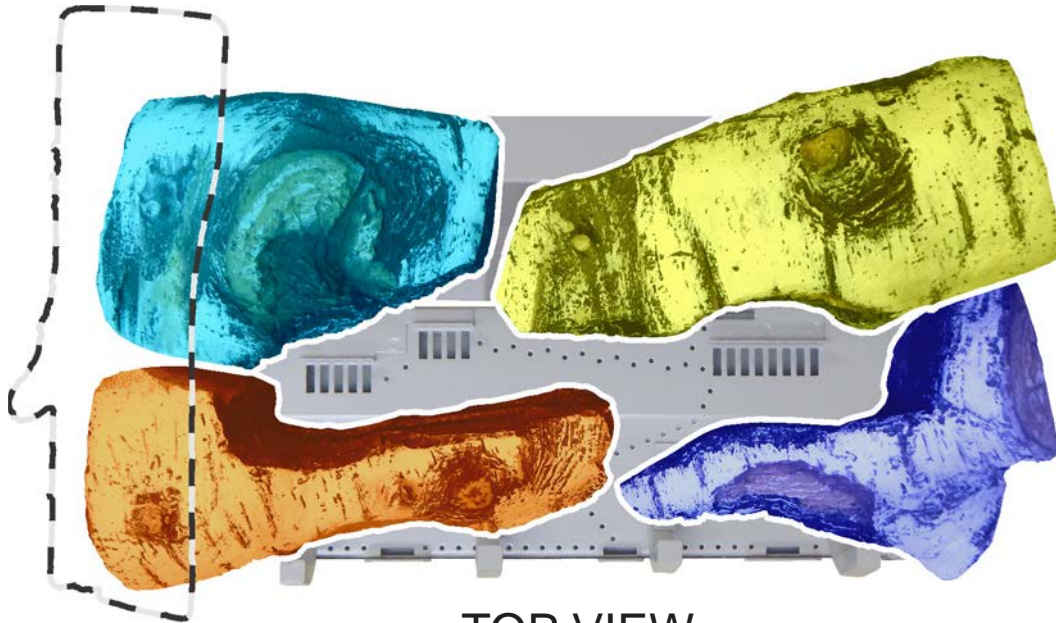

TOP VIEW

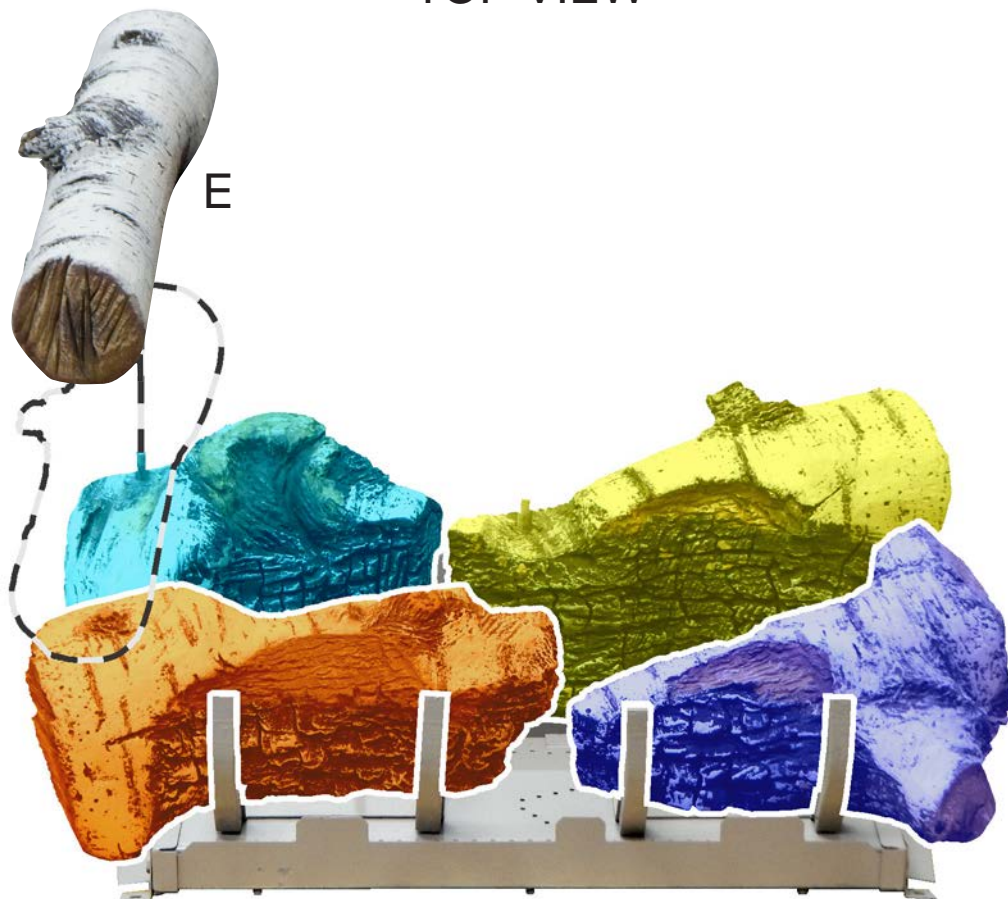

FRONT VIEW

LOG PLACEMENT LS18CBS (CONT'D)

- Place **Log (F)** onto left side pin of **Log (B)**.

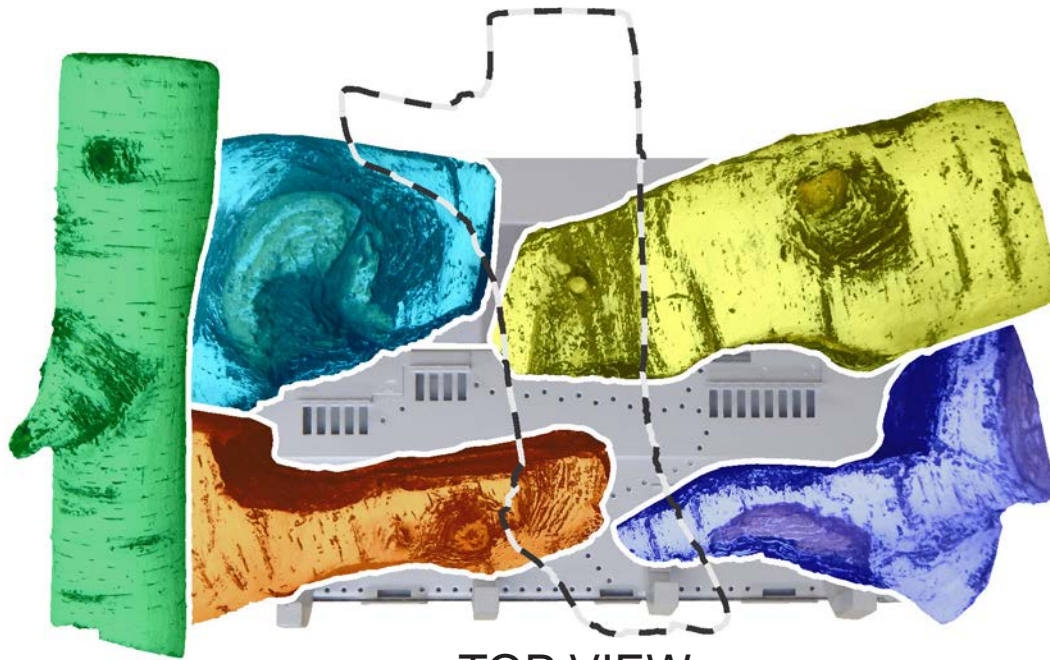

TOP VIEW

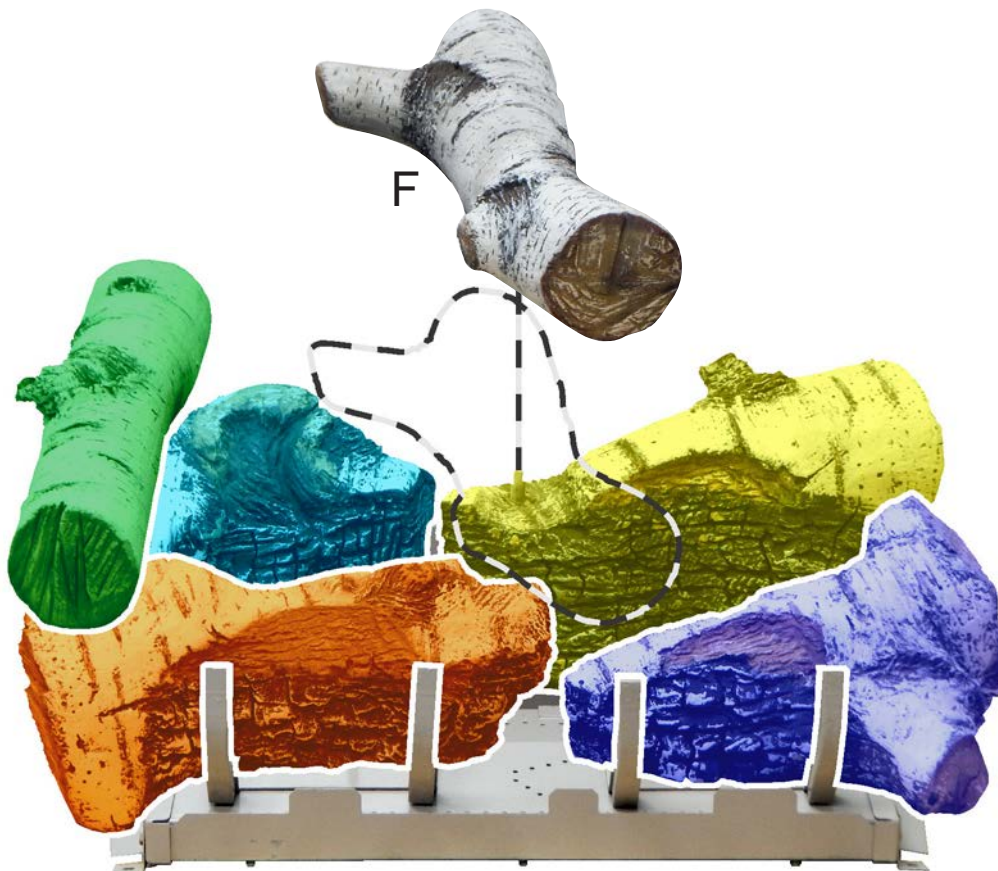

FRONT VIEW

LOG PLACEMENT LS18CBS (CONT'D)

7. Place **Log (G)** onto right side pin of **Log (B)** and right side of **Log (D)**.

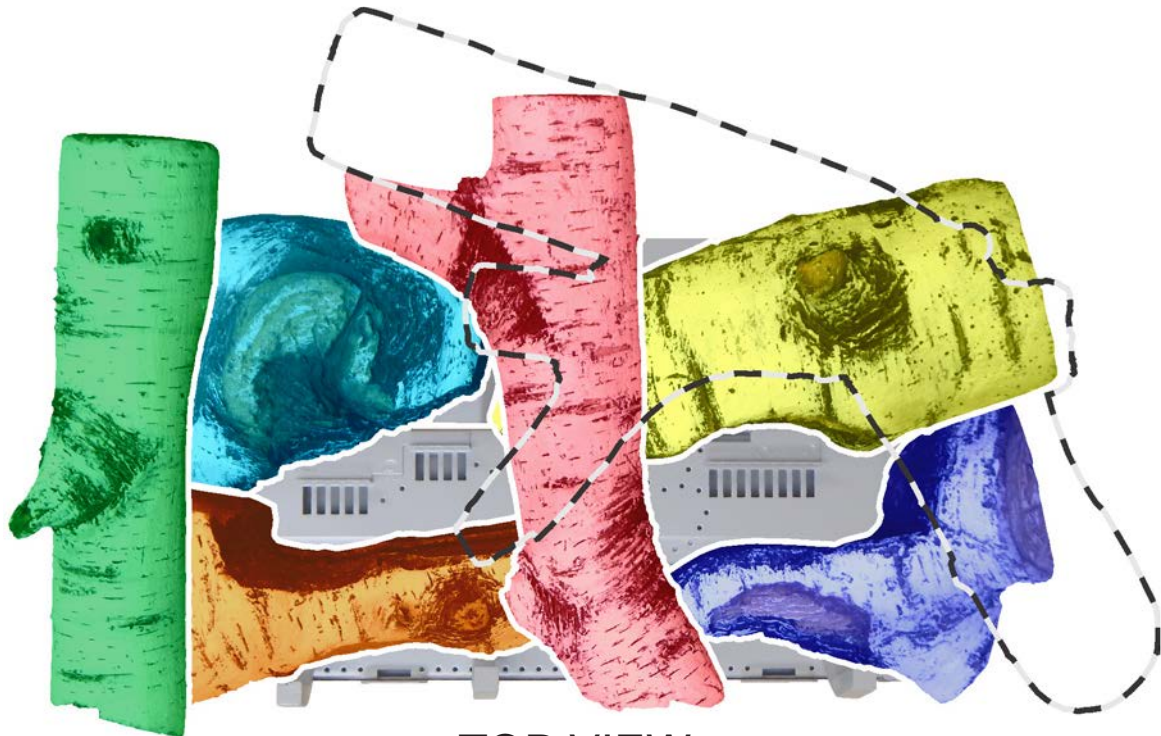

TOP VIEW

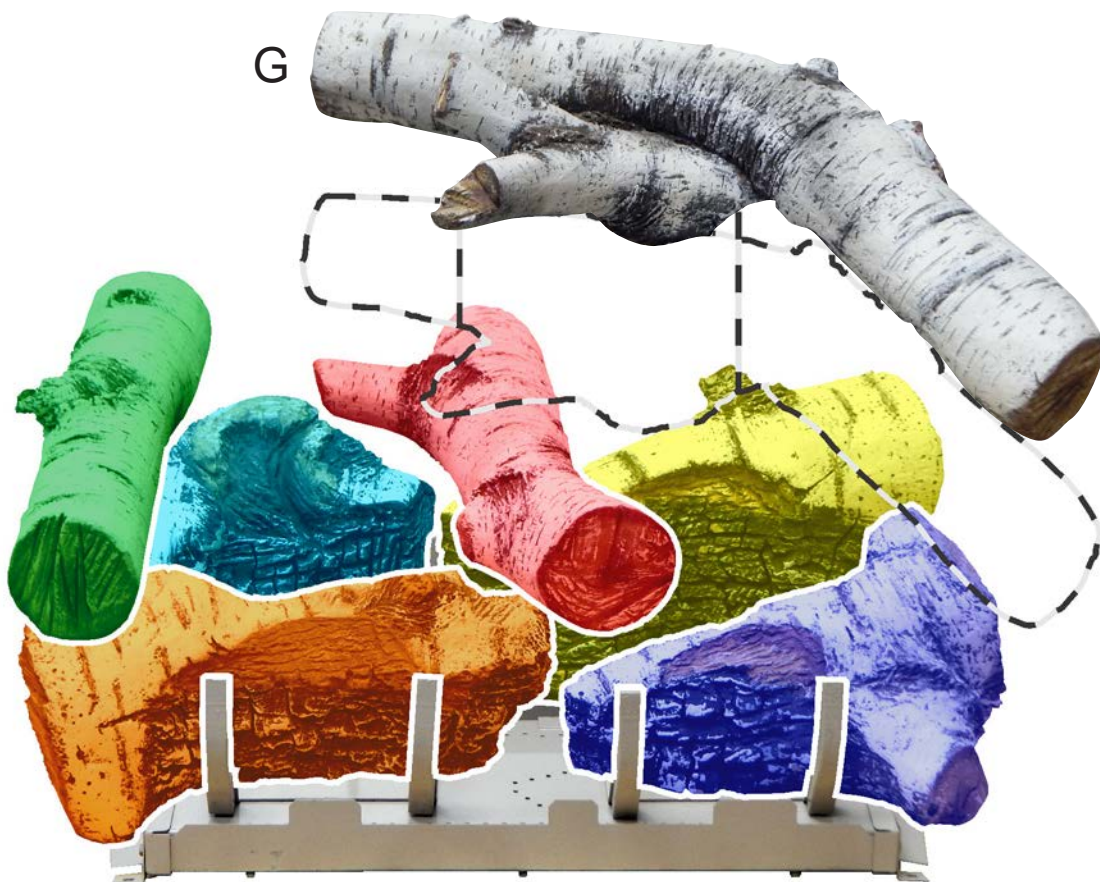

FRONT VIEW

LOG PLACEMENT LS18CBS (CONT'D)

8. Log placement is complete.



TOP VIEW



FRONT VIEW

EMBER PLACEMENT - LS(18,24,30)CBS

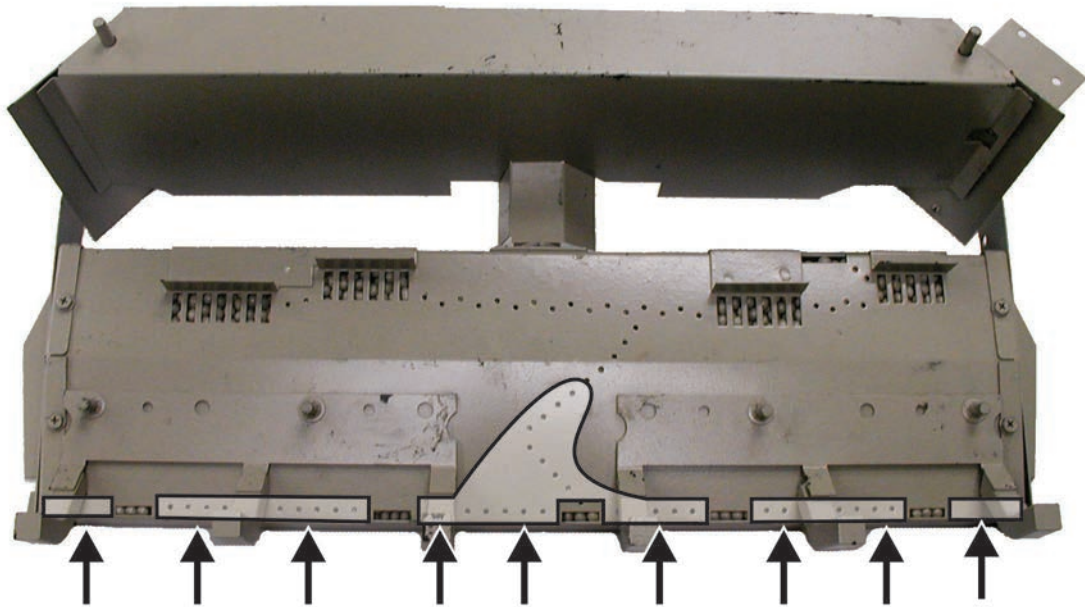





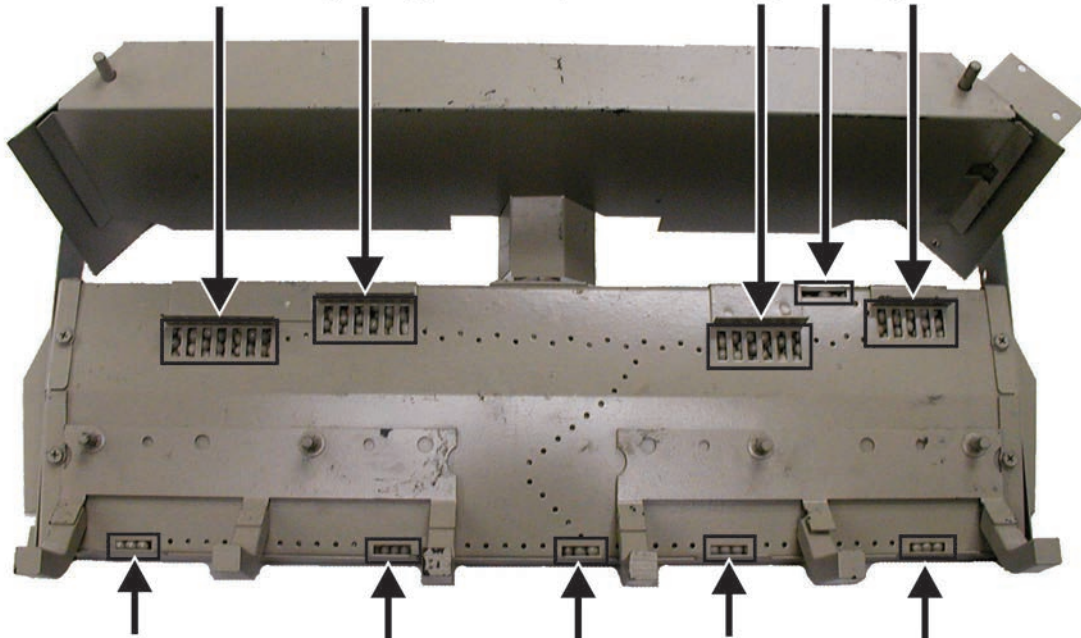







Area for glowing embers.

Do not cover any large rear ports with glowing embers.

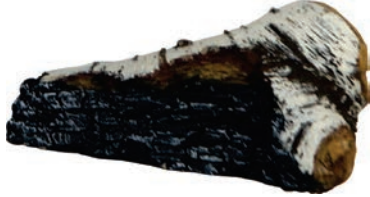

Do not cover any large front ports with glowing embers.

LOG IDENTIFICATION - LS24CBS

| PART NUMBER & DESCRIPTION | TOP VIEW | FRONT VIEW |
|----------------------------------|---|---|
| R13484 Rear Left Log (A) |  |  |
| R13485 Rear Right Log (B) |  |  |
| R13486 Front Left Log (C) |  |  |
| R13487 Front Right Log (D) |  |  |
| R13488 Side Left Log (E) |  |  |
| R13489 Center Log (F) |  |  |
| R13490 Side Right Log (G) |  |  |

LOG PLACEMENT - LS24CBS

Before you begin: Do not, handle these logs with your bare hands! Always wear gloves to prevent skin irritation. After handling logs, wash your hands gently with soap and water.

All Logs

The positioning of the logs is critical to the safe and clean operation of this heater. Sooting and other problems may result if the logs are not properly and firmly positioned in the appliance.

Refer to Figure 2 for the following warning.

⚠ WARNING

Failure to position the parts in accordance with this diagram or failure to use only parts specifically approved with this appliance may result in property damage or personal injury.

LS24CBS

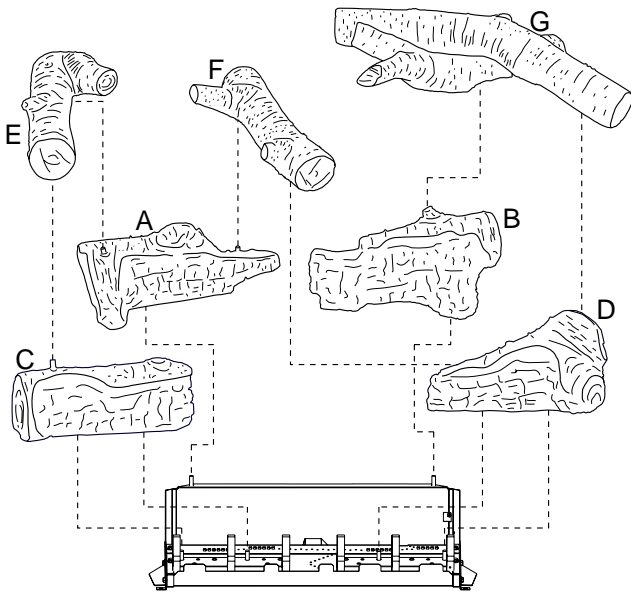

Figure 2

ATTENTION: Do not use Figure 2 to order replacement logs. Refer to Log Identification LS24CBS on Page 6 log to order logs for your appropriate model number.

The following **WARNING** applies when log set is installed onto an unvented gas burner assembly.

⚠ WARNING

This appliance is equipped for natural or propane gas. Field conversion is not permitted.

Apply glowing embers per the ember placement section of this manual on page 27. Replace glowing embers with appropriate part number from the table below from Empire Comfort Systems, Inc. Application of excess glowing embers may adversely affect performance of the heater.

⚠ WARNING

All previously applied loose material must be removed prior to reapplication.

LOG PLACEMENT - LS24CBS (CONT'D)

1. Place **Log (A)** onto left rear pin on rear log support.

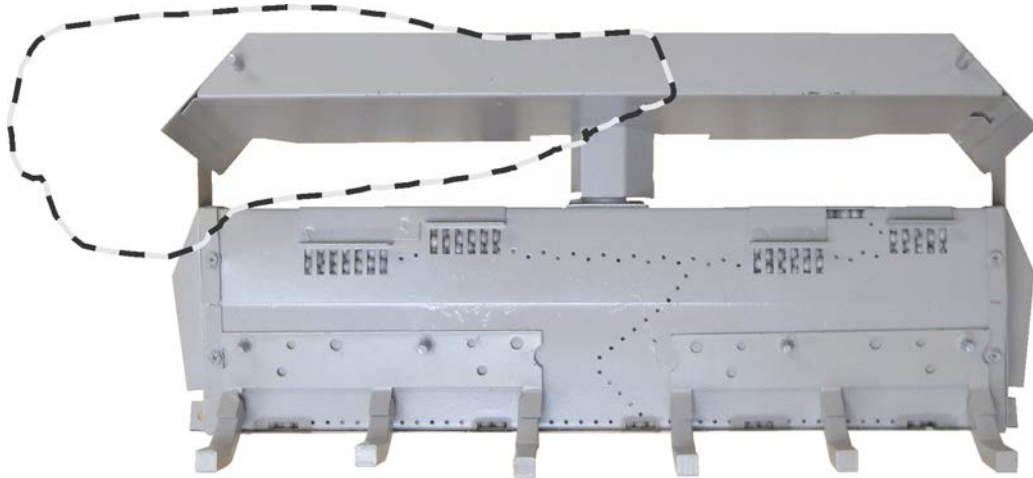

TOP VIEW

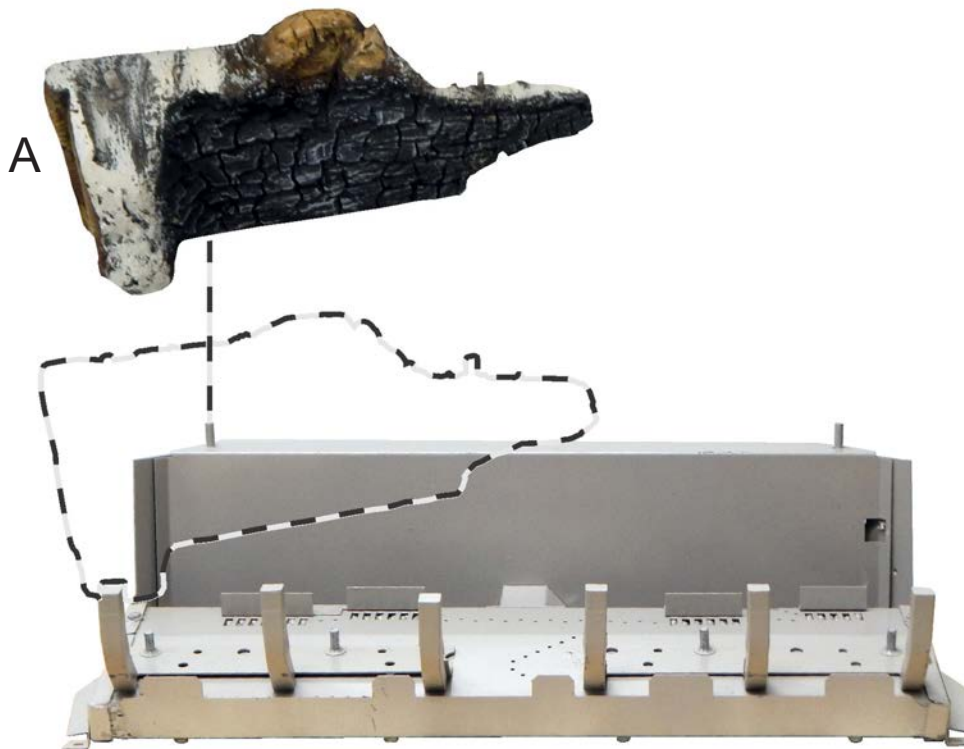

FRONT VIEW

LOG PLACEMENT - LS24CBS (CONT'D)

- Place **Log (B)** onto right rear pin on rear log support.

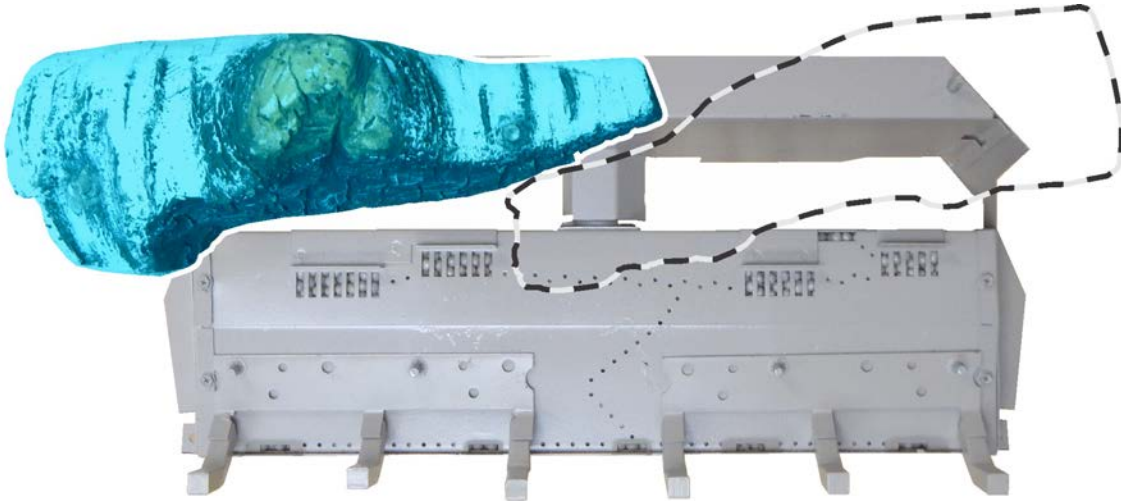

TOP VIEW

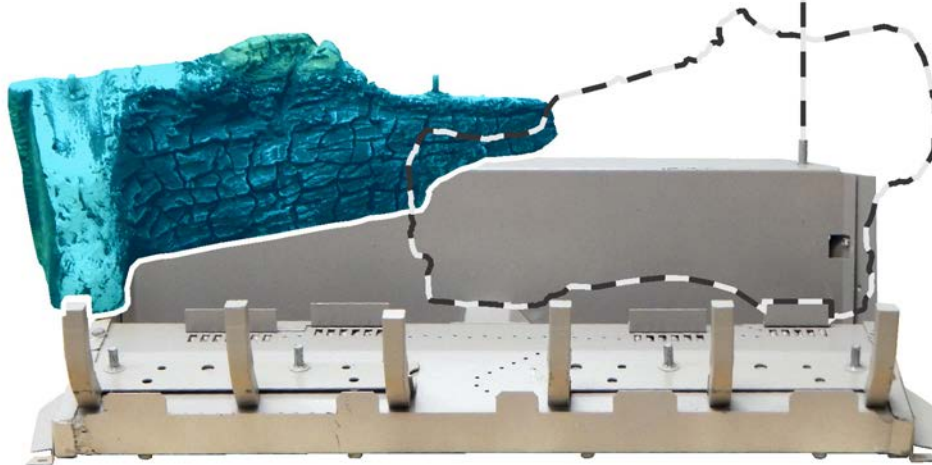

FRONT VIEW

LOG PLACEMENT - LS24CBS (CONT'D)

- Place **Log (C)** onto two (2) left front pins on burner pan.



TOP VIEW

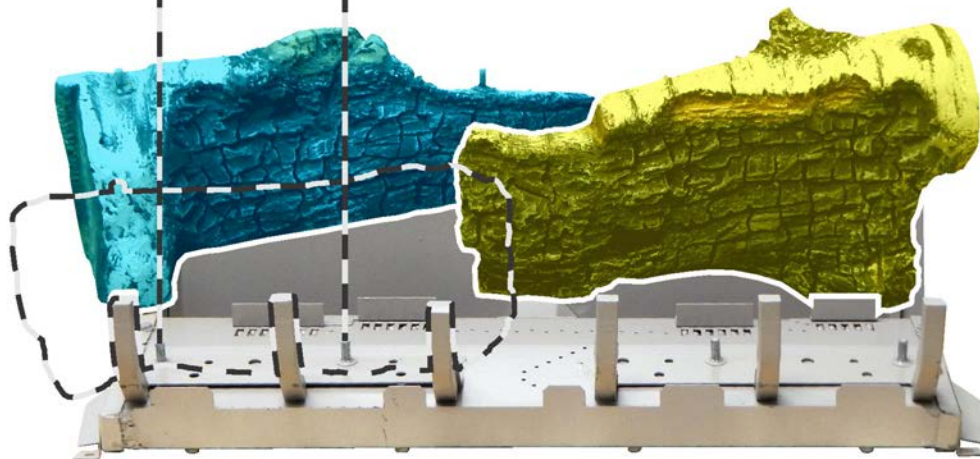

FRONT VIEW

LOG PLACEMENT - LS24CBS (CONT'D)

- Place **Log (D)** onto two (2) right front pins on burner pan.



TOP VIEW

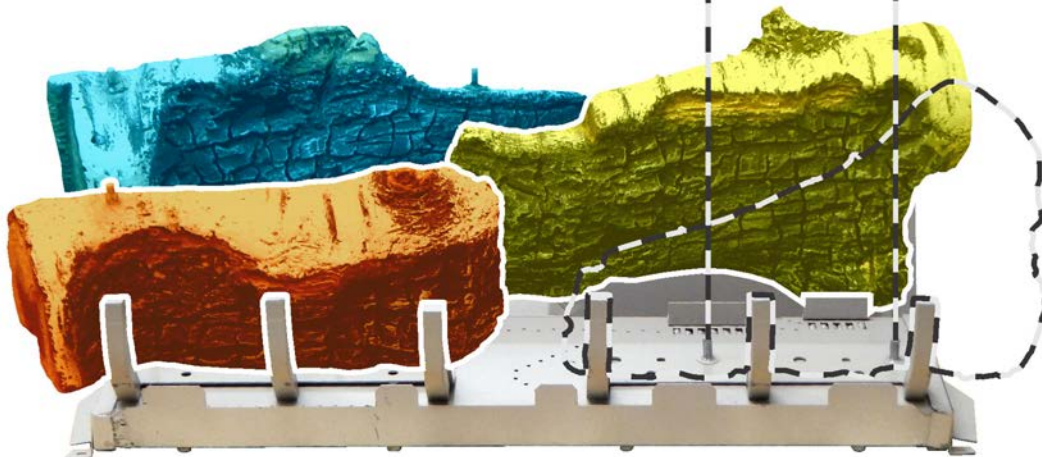

FRONT VIEW

LOG PLACEMENT - LS24CBS (CONT'D)

5. Place **Log (E)** onto left side pins of **Log (A)** and **Log (C)**.



TOP VIEW

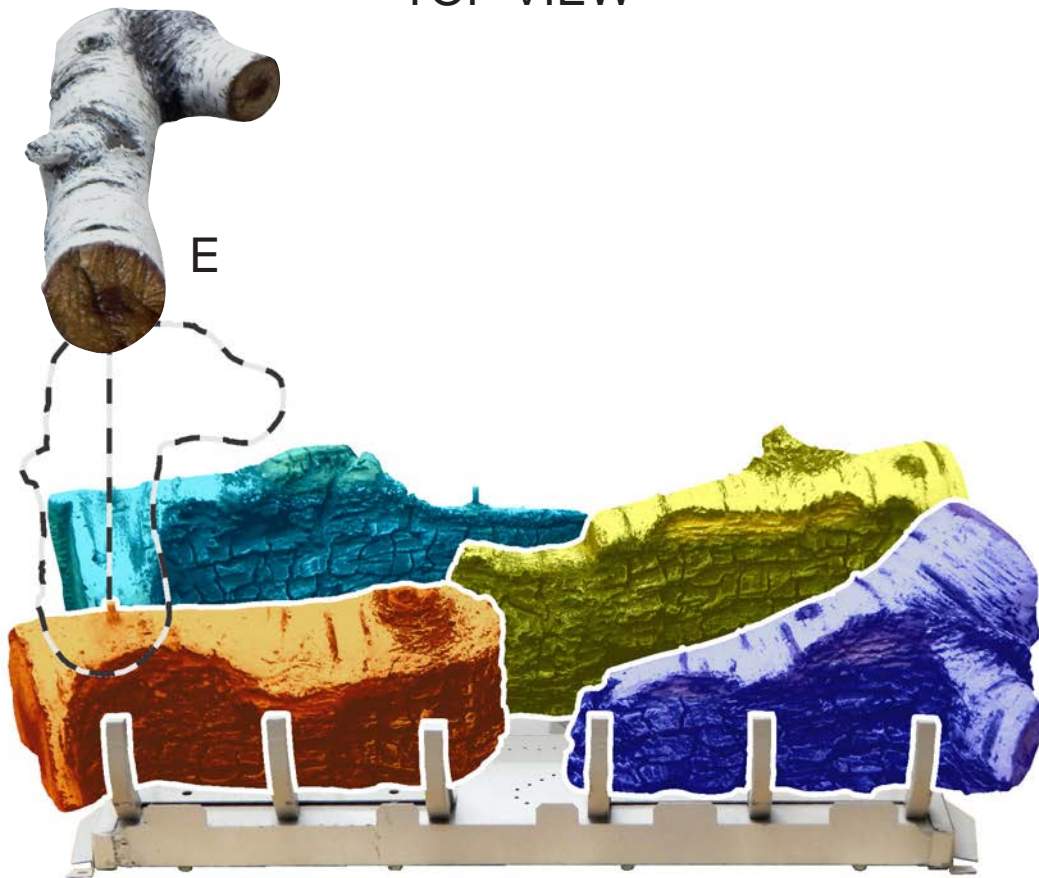

FRONT VIEW

LOG PLACEMENT - LS24CBS (CONT'D)

6. Place **Log (F)** onto left side pin of **Log (A)** and left side of **Log D**.



TOP VIEW

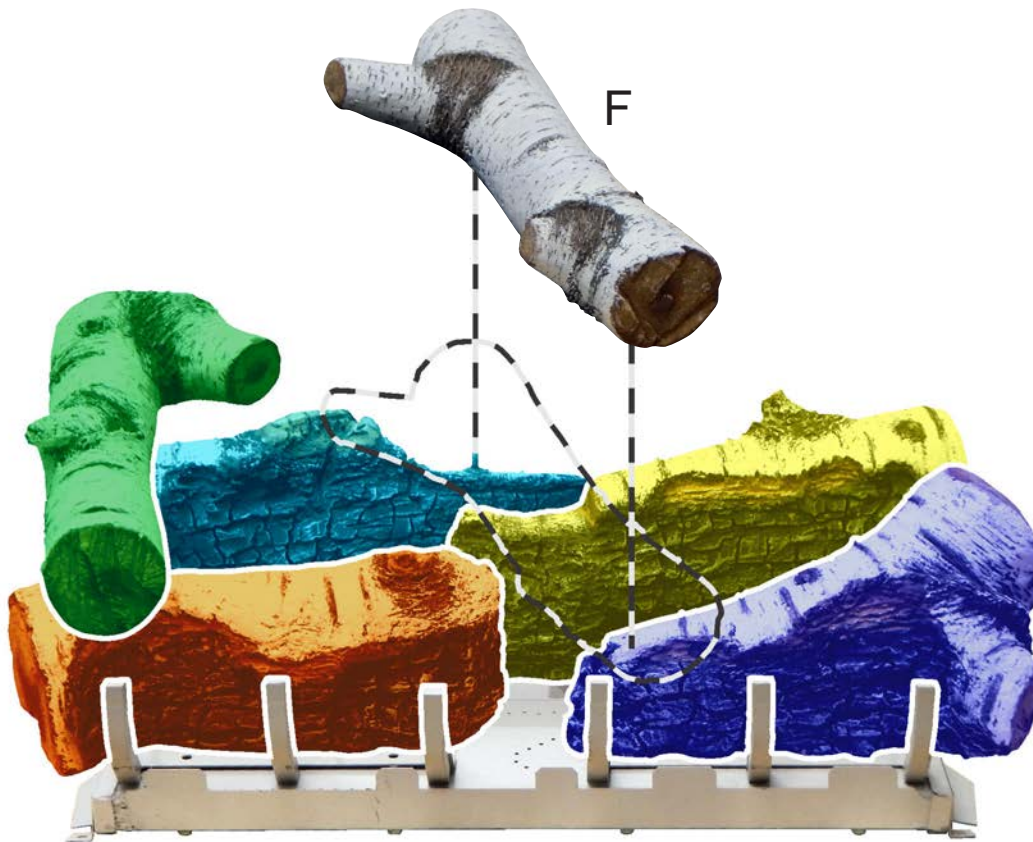

FRONT VIEW

LOG PLACEMENT - LS24CBS (CONT'D)

7. Place **Log (G)** onto right side pins of **Log (B)** and right side of **Log (D)**.

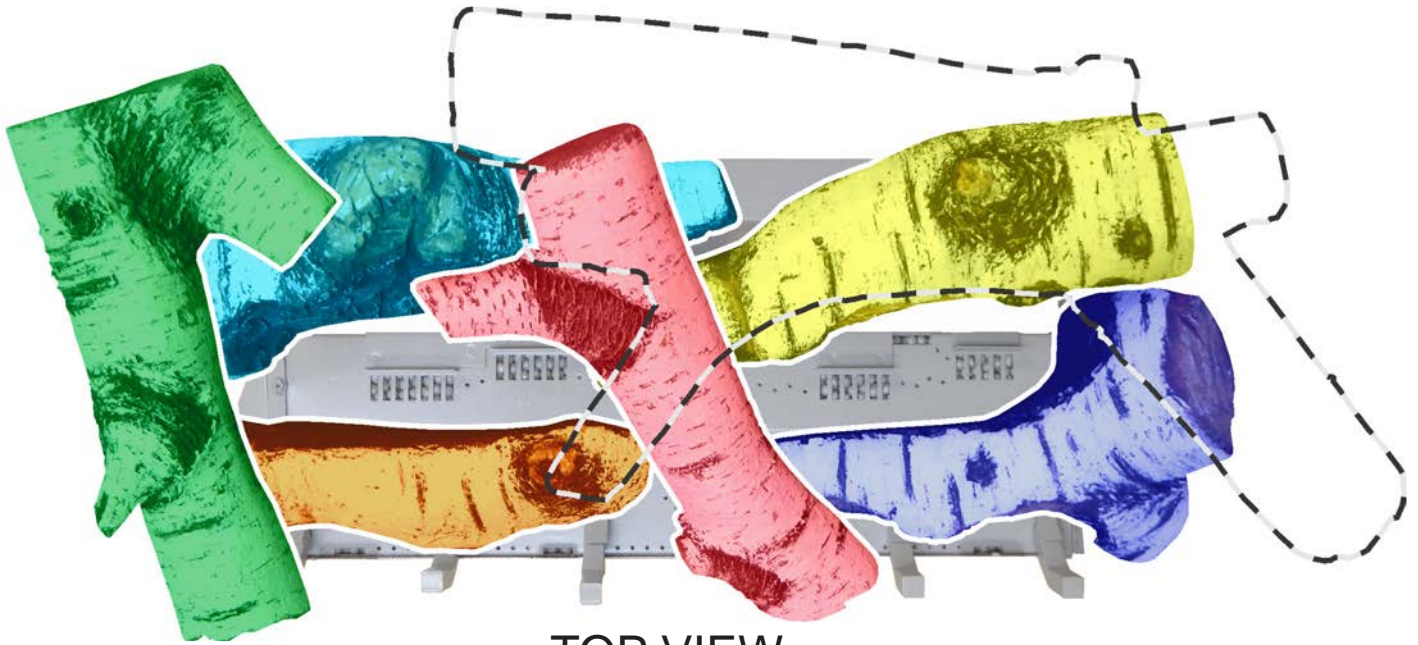

TOP VIEW

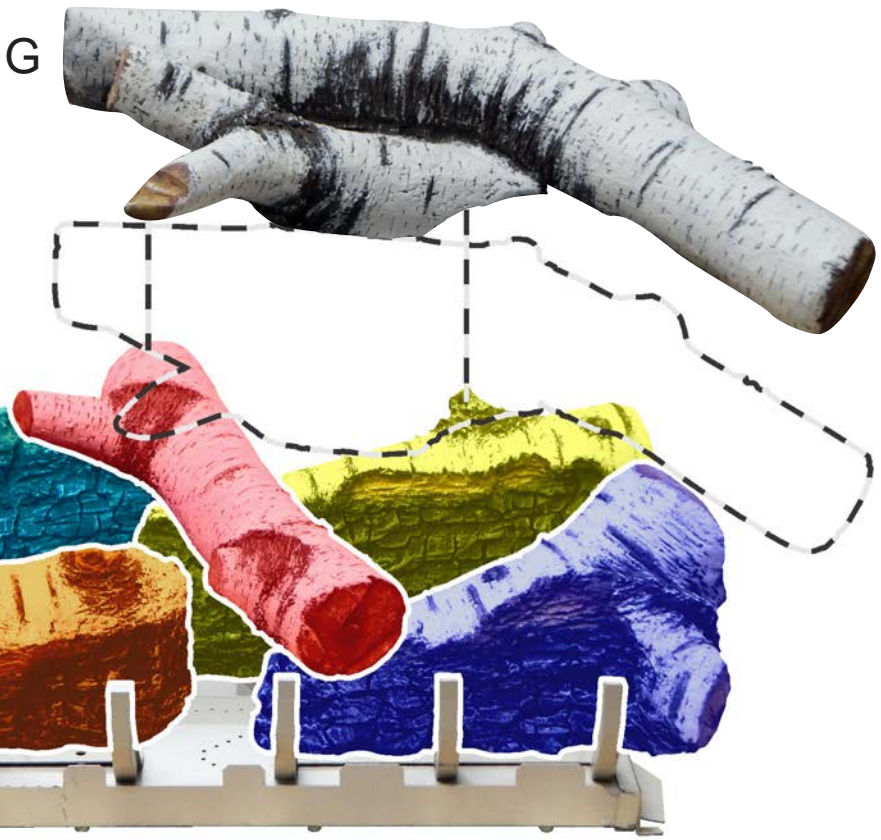

FRONT VIEW

LOG PLACEMENT - LS24CBS (CONT'D)

8. Log placement is complete.



TOP VIEW



FRONT VIEW

EMBER PLACEMENT - LS(18,24,30)CBS

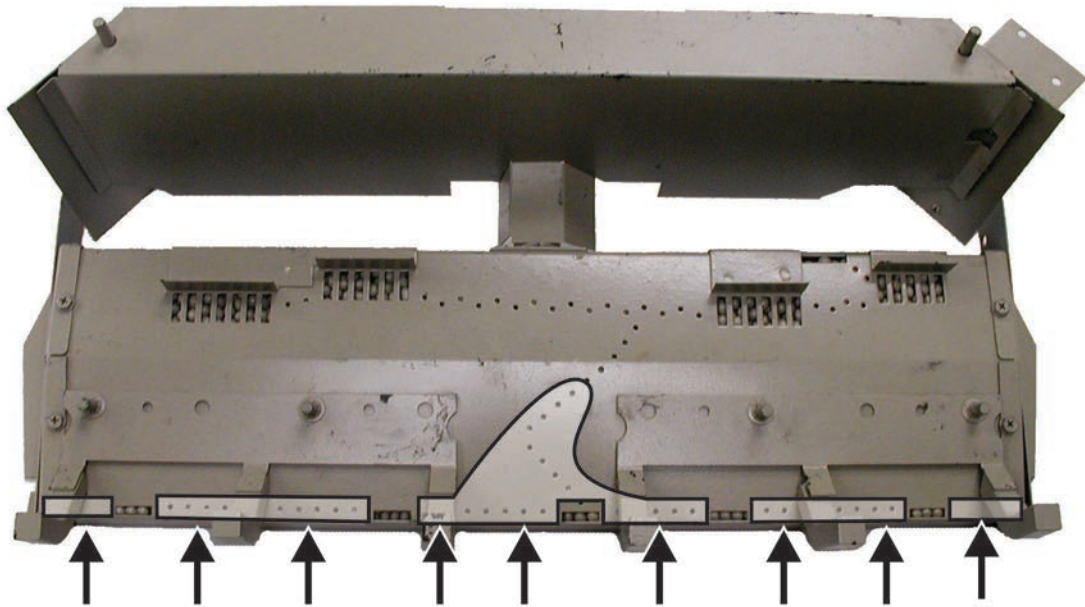





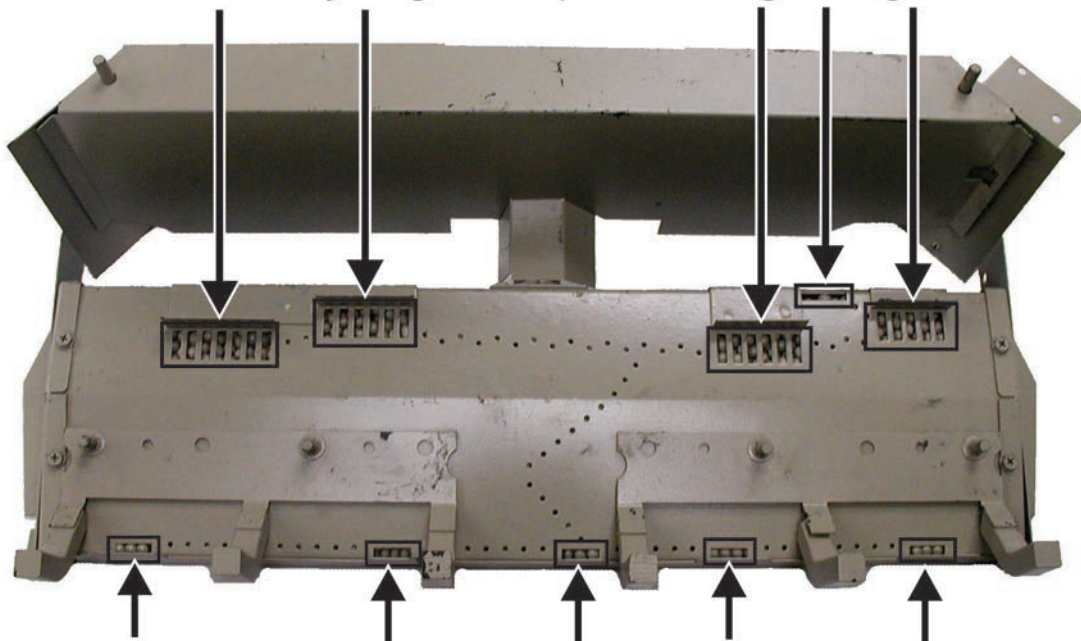







Area for glowing embers.

Do not cover any large rear ports with glowing embers.

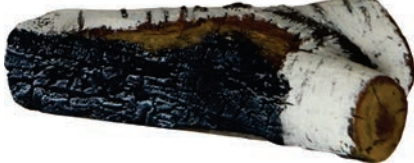

Do not cover any large front ports with glowing embers.

LOG IDENTIFICATION - LS30CBS

| PART NUMBER & DESCRIPTION | TOP VIEW | FRONT VIEW |
|---------------------------------|---|---|
| R13503 Rear Left Log (A) |  |  |
| R13504 Rear Right Log (B) |  |  |
| R13505 Front Left Log (C) |  |  |
| R13506 Center Log (D) |  |  |
| R13488 Side Left Log (E) |  |  |
| R13489 Side Left Log (F) |  |  |
| R13507 Side Right Log (G) |  |  |

LOG PLACEMENT - LS30CBS

Before you begin: Do not, handle these logs with your bare hands! Always wear gloves to prevent skin irritation. After handling logs, wash your hands gently with soap and water.

All Logs

The positioning of the logs is critical to the safe and clean operation of this heater. Sooting and other problems may result if the logs are not properly and firmly positioned in the appliance.

Refer to Figure 3 for the following warning.

⚠ WARNING

Failure to position the parts in accordance with this diagram or failure to use only parts specifically approved with this appliance may result in property damage or personal injury.

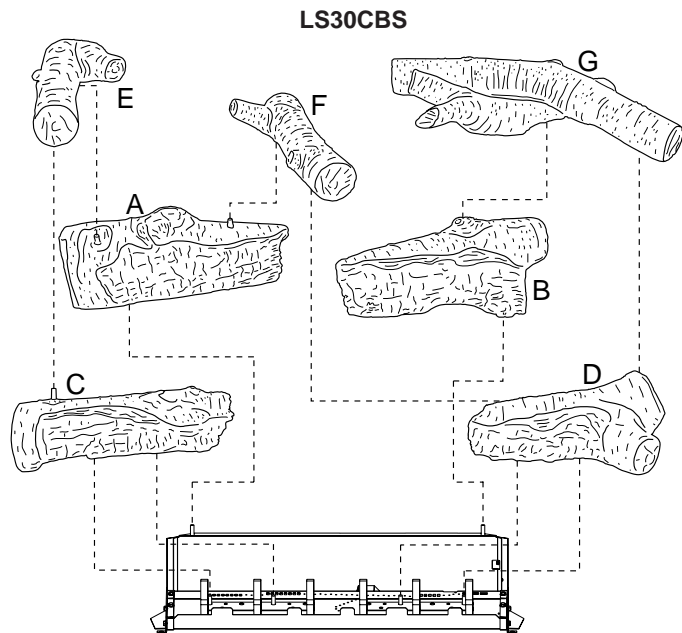

Figure 3

ATTENTION: Do not use **Figure 3** to order replacement logs. Refer to Log Identification LS30CBS on Page 6 log to order logs for your appropriate model number.

The following **WARNING** applies when log set is installed onto an unvented gas burner assembly.

⚠ WARNING

This appliance is equipped for natural or propane gas. Field conversion is not permitted.

Apply glowing embers per the ember placement section of this manual on page 38. Replace glowing embers with appropriate part number from the table below from Empire Comfort Systems, Inc. Application of excess glowing embers may adversely affect performance of the heater.

⚠ WARNING

All previously applied loose material must be removed prior to reapplication.

LOG PLACEMENT - LS30CBS (CONT'D)

1. Place **Log (A)** onto left rear pin on rear log support.

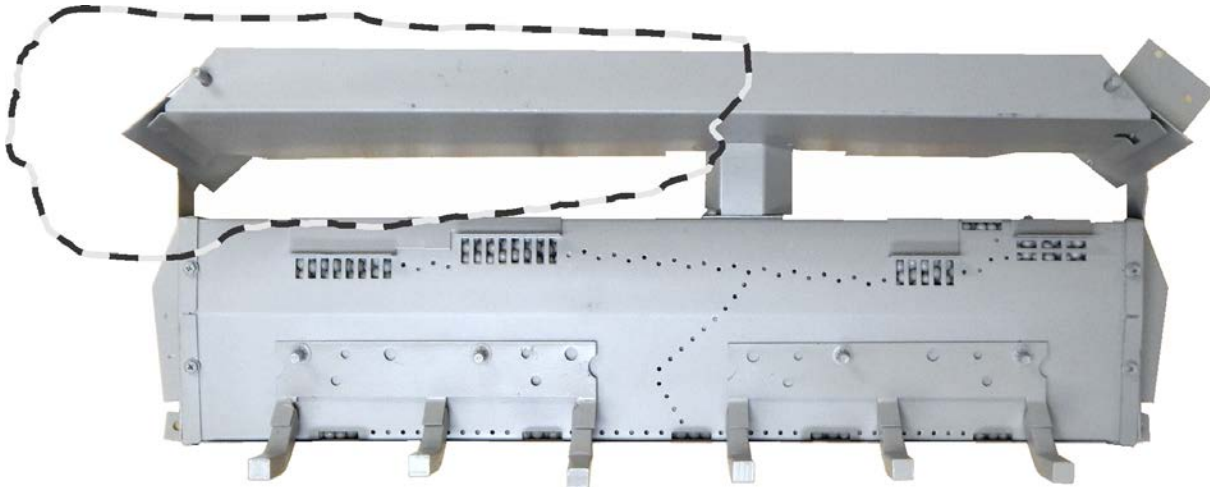

TOP VIEW

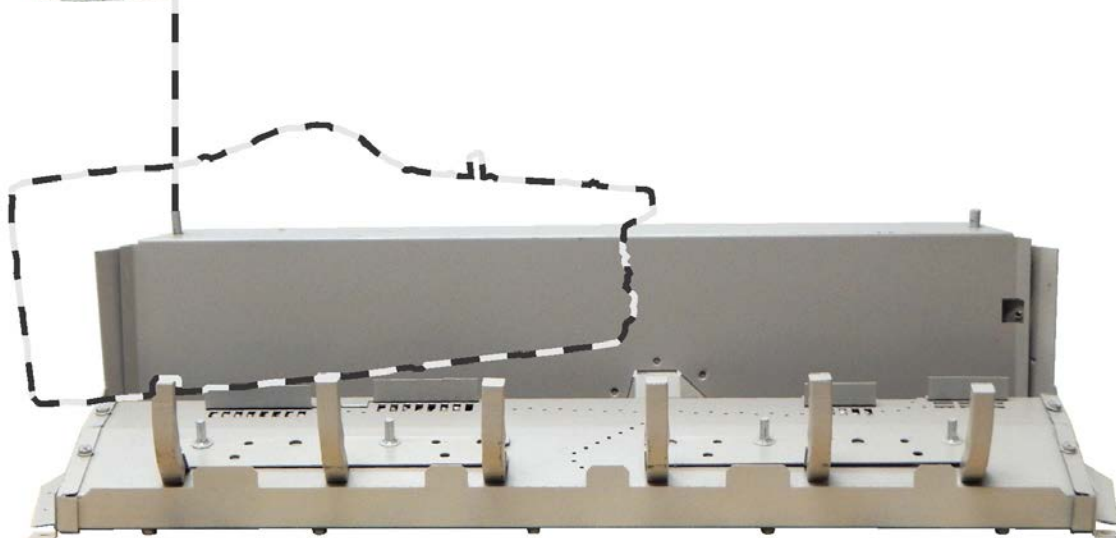

FRONT VIEW

LOG PLACEMENT - LS30CBS (CONT'D)

- Place **Log (B)** onto right rear pin on rear log support.

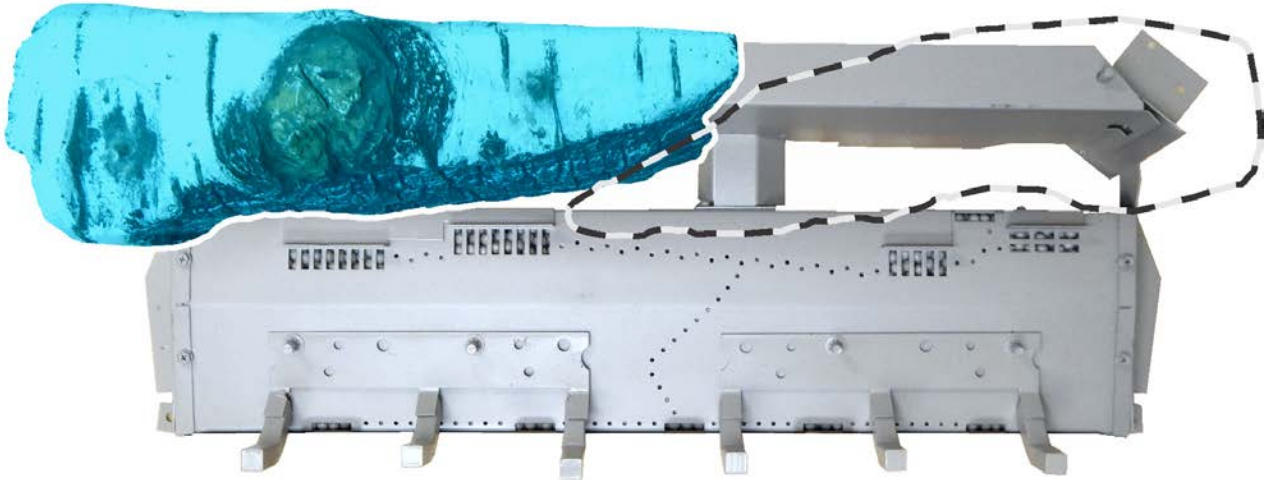

TOP VIEW

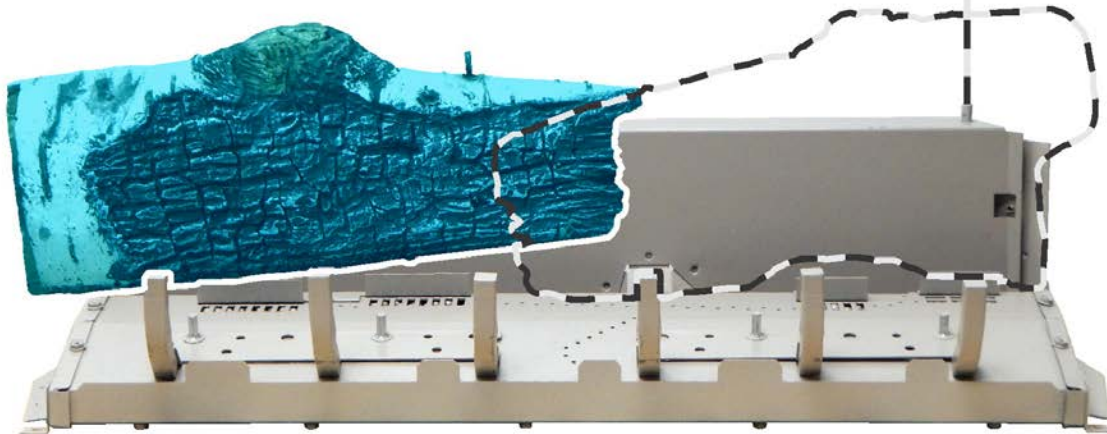

FRONT VIEW

LOG PLACEMENT - LS30CBS (CONT'D)

3. Place **Log (C)** onto two (2) left front pins on burner pan.

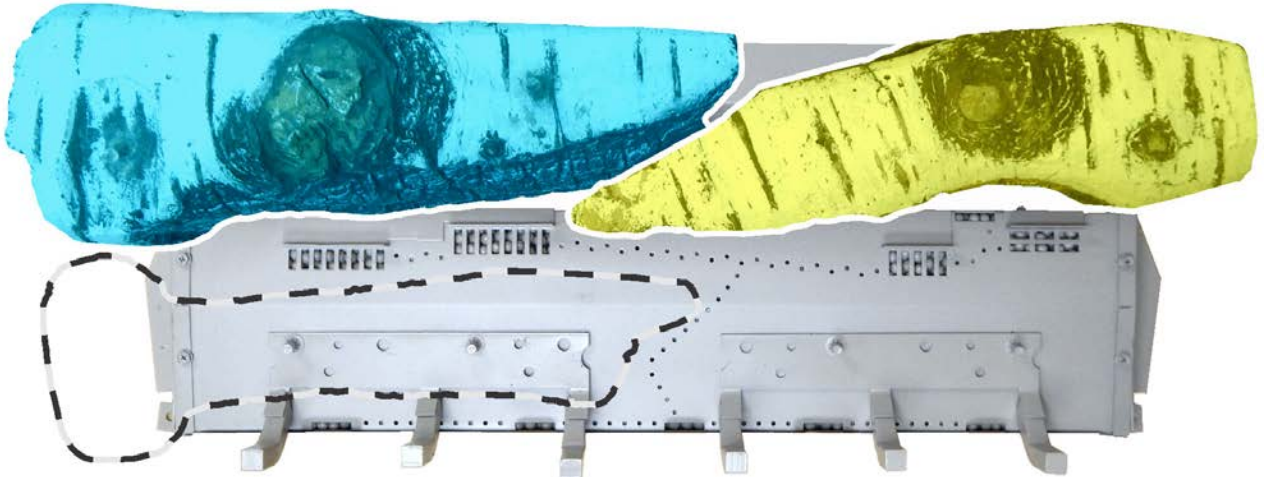

TOP VIEW

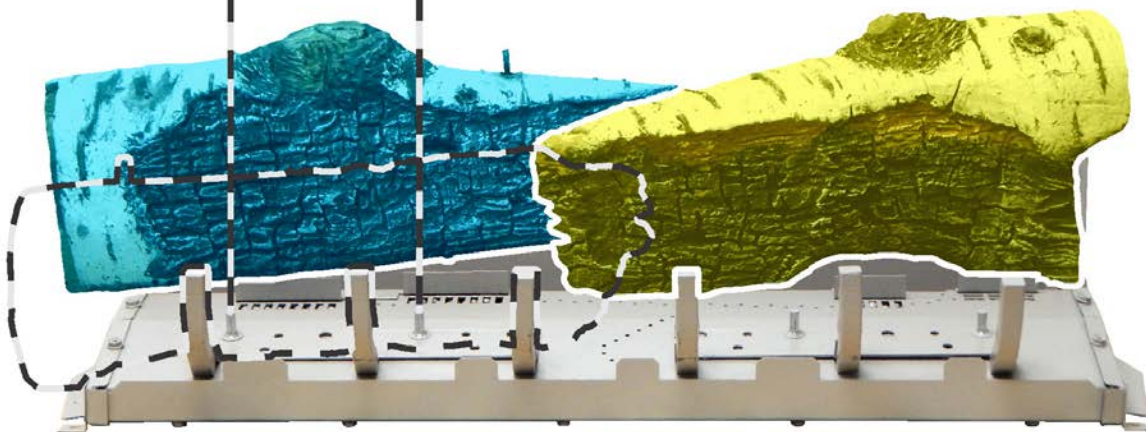

FRONT VIEW

LOG PLACEMENT - LS30CBS (CONT'D)

- Place **Log (D)** onto two (2) right front pins on burner pan.



TOP VIEW

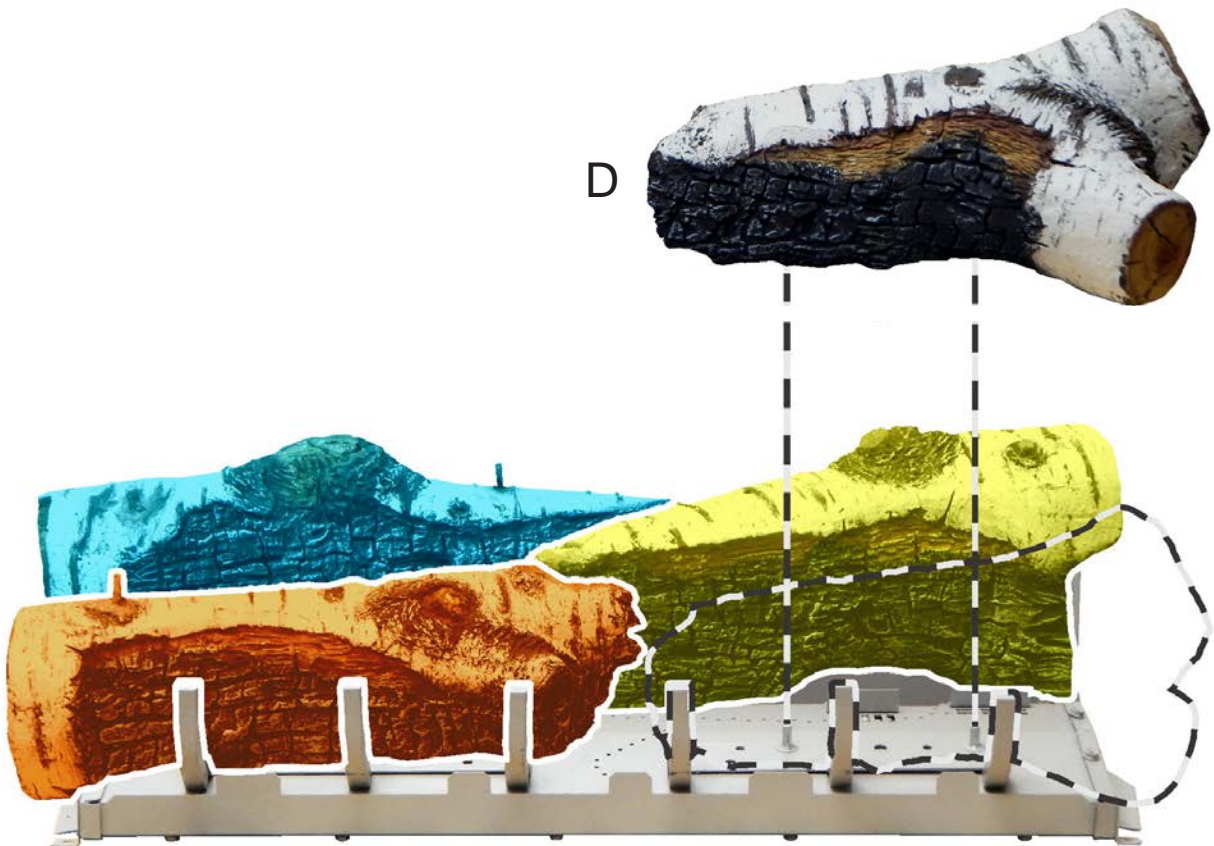

FRONT VIEW

LOG PLACEMENT - LS30CBS (CONT'D)

5. Place **Log (E)** onto left side pins of **Log (A)** and **Log (C)**.



TOP VIEW



E



FRONT VIEW

LOG PLACEMENT - LS30CBS (CONT'D)

6. Place **Log (F)** onto right side pin of **Log (A)** and left side of Log **(D)**.



TOP VIEW

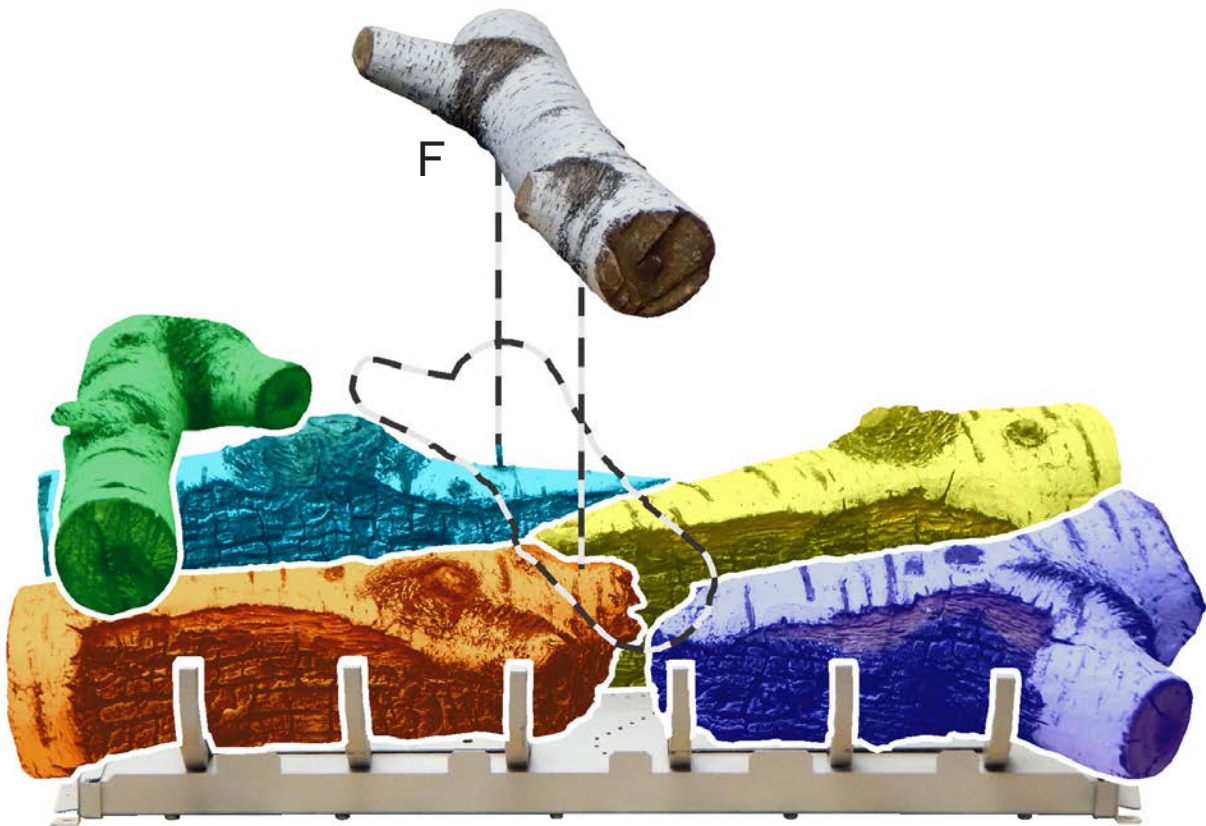

FRONT VIEW

LOG PLACEMENT - LS30CBS (CONT'D)

7. Place **Log (G)** onto right side pin of **Log (B)** and right side of **Log (D)**.

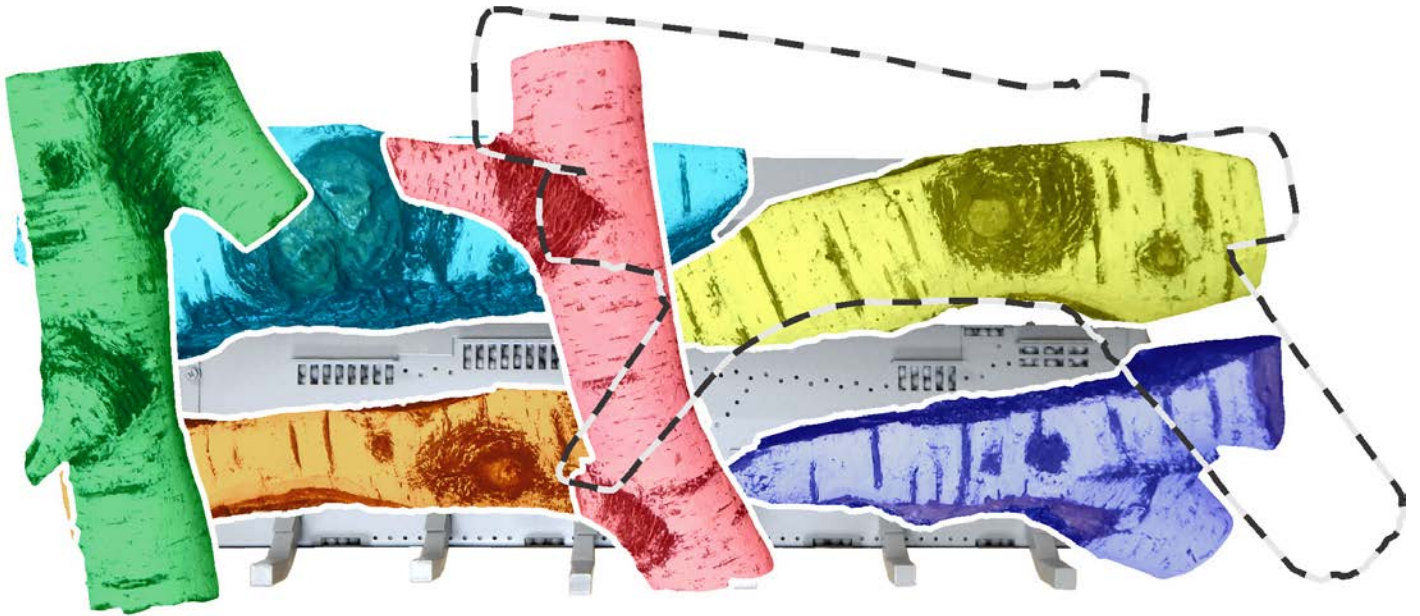

TOP VIEW

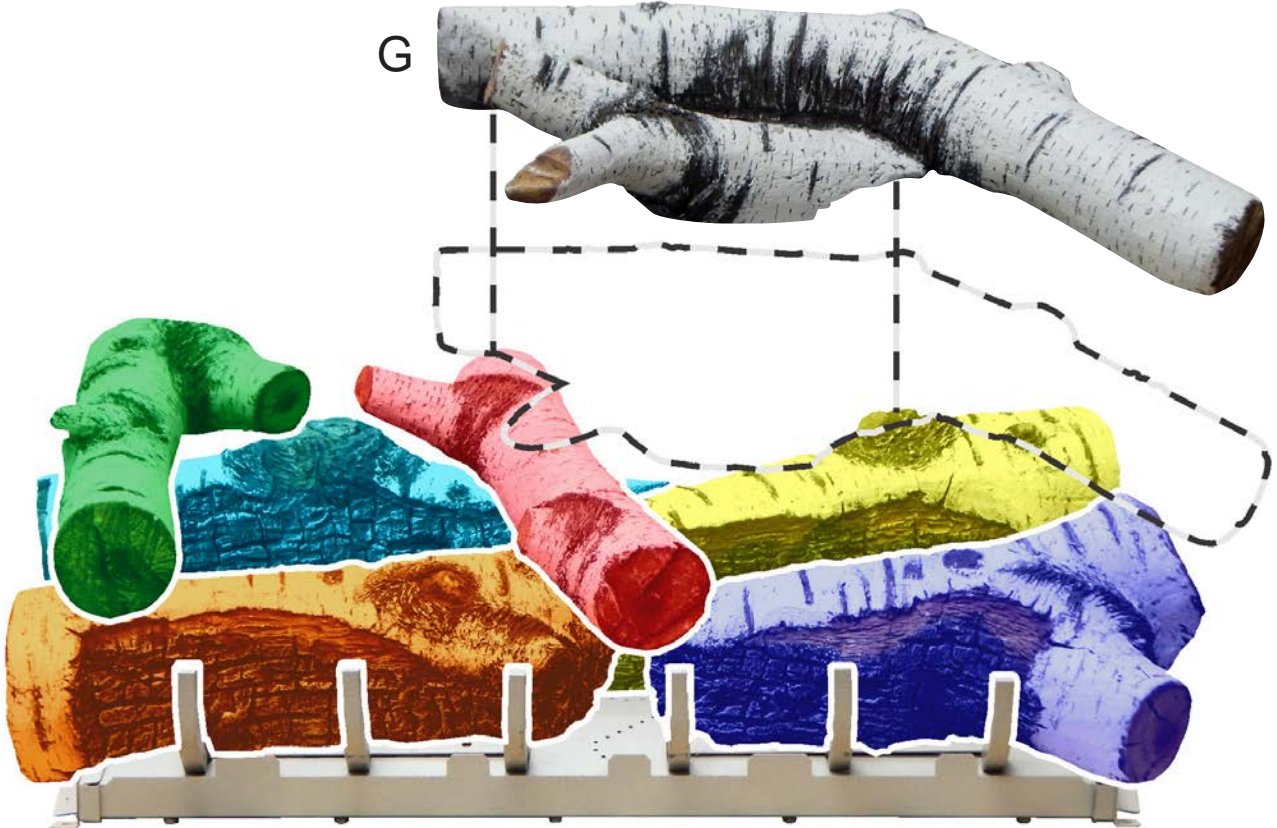

FRONT VIEW

LOG PLACEMENT - LS30CBS (CONT'D)

8. Log placement is complete.



TOP VIEW



FRONT VIEW

EMBER PLACEMENT - LS(18,24,30)CBS

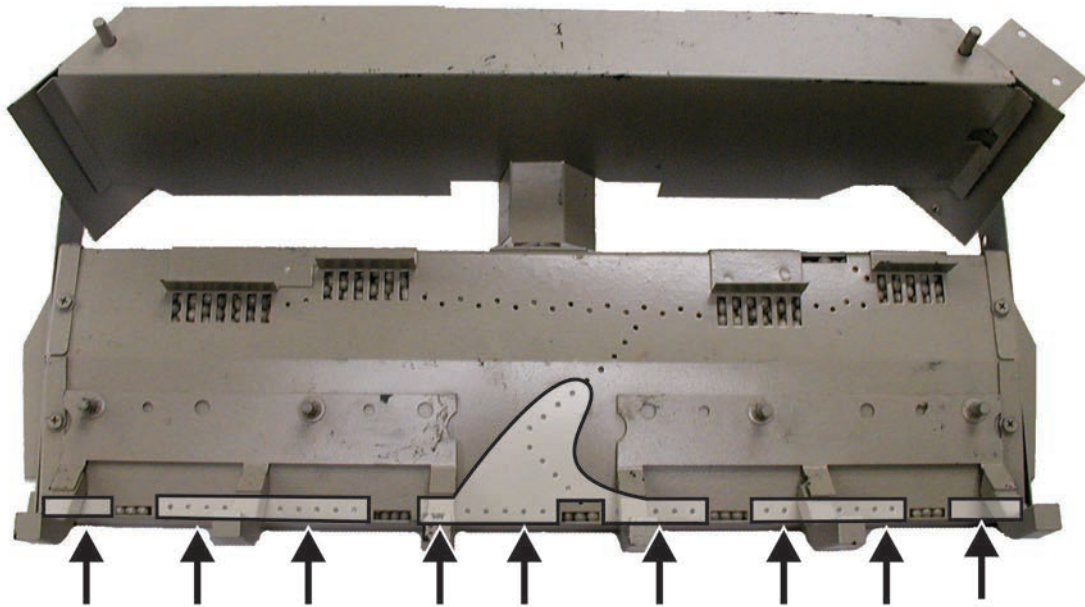

Area for glowing embers.

Do not cover any large rear ports with glowing embers.

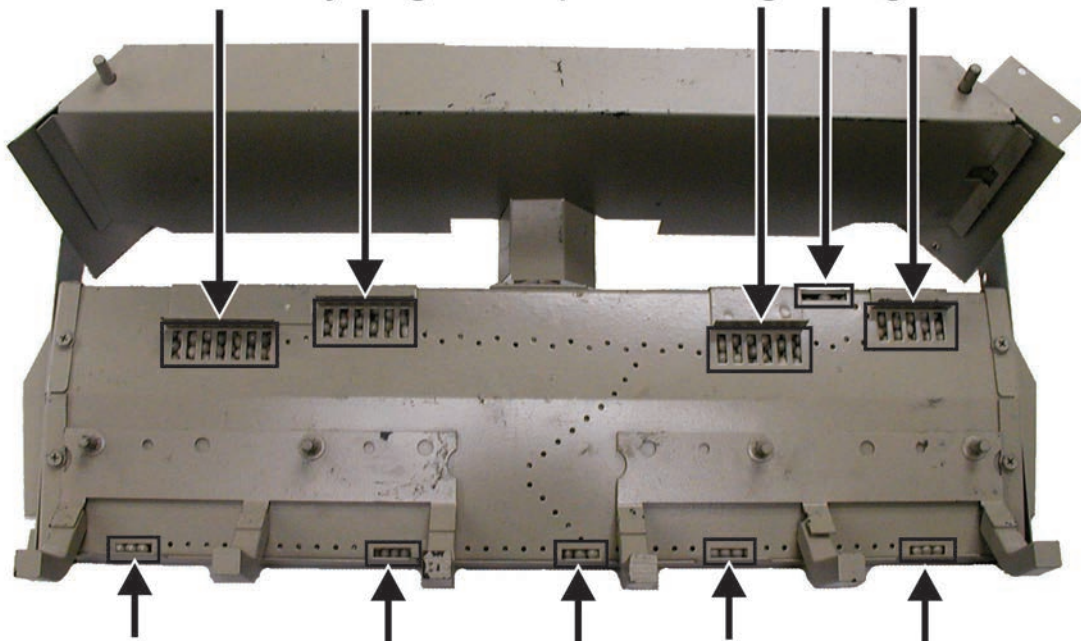

Do not cover any large front ports with glowing embers.

MASTER PARTS DISTRIBUTOR LIST

To Order Parts Under Warranty, please contact your local Empire dealer. See the dealer locator at www.empirecomfort.com. To provide warranty service, your dealer will need your name and address, purchase date and serial number, and the nature of the problem with the unit.

To Order Parts After the Warranty Period, please contact your dealer or one of the Master Parts Distributors listed below. This list changes from time to time. For the current list, please click on the Master Parts button at www.empirecomfort.com. Please note: Master Parts Distributors are independent businesses that stock the most commonly ordered Original Equipment repair parts for Heaters, Grills, and Fireplaces manufactured by Empire Comfort Systems Inc.

Dey Distributing

1401 Willow Lake Boulevard
Vadnais Heights, MN 55101

Phone: 651-490-9191

Toll Free: 800-397-1339

Website: www.deydistributing.com

Parts: Heater, Hearth and Grills

F. W. Webb Company

200 Locust Street
Hartford, CT 06114

Phone: 860-722-2433

Toll Free: 800-243-9360

Fax: 860-293-0479

Toll Free Fax: 800-274-2004

Website: www.fwwebb.com

Parts: Heater, Hearth and Grills

East Coast Energy Products

10 East Route 36
West Long Branch, NJ 07764

Phone: 732-870-8809

Toll Free: 800-755-8809

Fax: 732-870-8811

Website: www.eastcoastenergy.com

Parts: Heater, Hearth and Grills

HOW TO ORDER REPAIR PARTS

Parts Not Under Warranty

Parts can be ordered through your Service Person, Dealer, or a Master Parts Distributor. See this page for the Master Parts Distributors list. For best results, the **service person or dealer** should order parts through the distributor. Parts can be shipped directly to the **service person/dealer**.

Warranty Parts

Warranty parts will need a proof of purchase and can be ordered by your Service Person or Dealer. Proof of purchase is **required** for warranty parts.

All parts listed in the Parts List have a Part Number. When ordering parts, first obtain the Model Number and Serial Number from the name plate on your equipment. Then determine the Part Number (**not** the Index Number) and the Description of each part from the following illustration and part list. Be sure to give all this information . . .

Appliance Model Number _____ Part Description _____

Appliance Serial Number _____ Part Number _____

Type of Gas (Propane or Natural) _____

Do not order bolts, screws, washers or nuts. They are standard hardware items and can be purchased at any local hardware store.

Shipments contingent upon strikes, fires and all causes beyond our control.



Empire Comfort Systems Inc.
Belleville, IL

If you have a general question
about our products, please e-mail
us at info@empirecomfort.com.

If you have a service or repair
question, please contact your dealer.

SINCE 1932

www.empirecomfort.com